



- 03** STANDARD LINE
- 13** LIGHT LINE
- 21** PLUS LINE
- 27** PRO LINE
- 33** BOXING LINE
- 37** WORKOUT LINE
- 43** GYMNASTIC LINE
- 49** KIDS LINE
- 53** NEW CARDIO LINE

STREET BARBELL GROUP

WELCOME TO

STREET BARBELL

Street Barbell is a reputable outdoor fitness equipment provider with more than seven years of experience adhering to strict European safety standards. Our products are renowned among both amateurs and professionals and enjoy global demand.

Our distinctive feature is our patented adjustable weight system — a revolutionary innovation that has no analogues.



STANDARD LINE

26 TRAINERS

Advanced equipment
with convergent and
divergent biomechanics

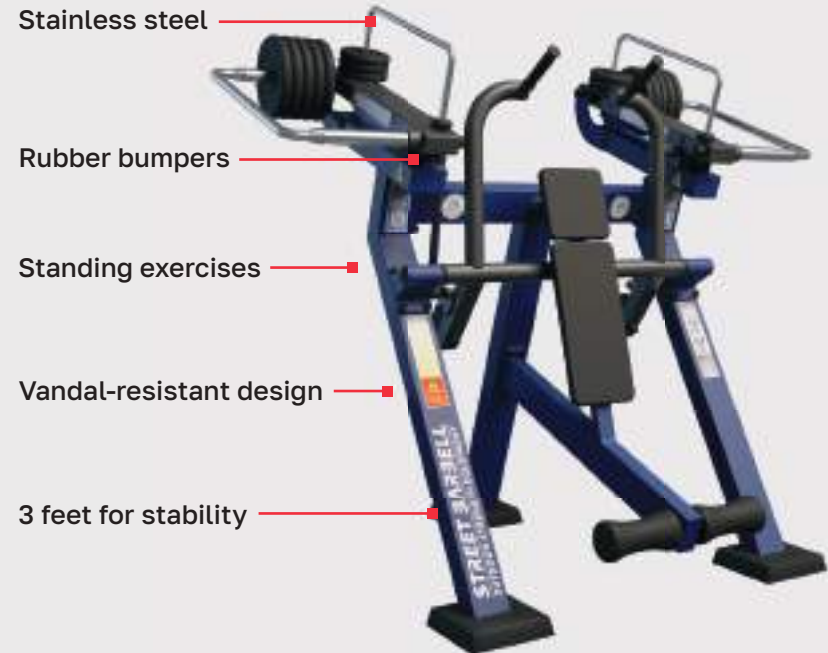

STREET BARBELL GROUP





Watch
the video

MB 7.29 Vertical Press



PRODUCT SPECIFICATION

	Length	1380 mm
	Width	2110 mm
	Height	2130 mm
	Equipment weight	265 kg
	Maximum load	115 kg
	User height	140 cm
	User age	14 +

TARGET MUSCLES

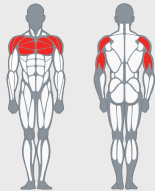

Street Barbell Standard Line represents outdoor fitness equipment with variable load of professional level for deep training of all the main muscles of the human body.



Patented
weight system



Protective
pads





Video
instructions





MB 7.30 Chest Press

PRODUCT SPECIFICATION

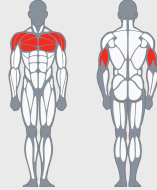

	Length	1350 mm
	Width	2010 mm
	Height	2110 mm
	Equipment weight	335 kg
	Maximum load	155 kg
	User height	140 cm
	User age	14 +

TARGET MUSCLES



MB 7.32 Reverse Butterfly

PRODUCT SPECIFICATION

	Length	1560 mm
	Width	1810 mm
	Height	2110 mm
	Equipment weight	285 kg
	Maximum load	95 kg
	User height	140 cm
	User age	14 +

TARGET MUSCLES

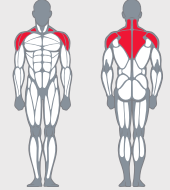

MB 7.31 Butterfly

PRODUCT SPECIFICATION

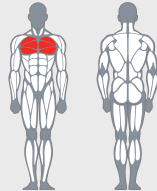

	Length	1350 mm
	Width	1810 mm
	Height	2110 mm
	Equipment weight	285 kg
	Maximum load	95 kg
	User height	140 cm
	User age	14 +

TARGET MUSCLES



MB 7.33 Dumbbell set (Light)

PRODUCT SPECIFICATION

	Length	1380 mm
	Width	2110 mm
	Height	2130 mm
	Equipment weight	265 kg
	Maximum load	115 kg
	User height	140 cm
	User age	14 +

TARGET MUSCLES

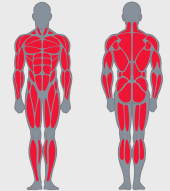

STREET BARBELL GROUP

MB 7.34 Dumbbell set (Heavy)



PRODUCT SPECIFICATION

	Length	1450 mm
	Width	2360 mm
	Height	1100 mm
	Equipment weight	265 kg
	Maximum load	80 kg
	User height	140 cm
	User age	14 +

TARGET MUSCLES

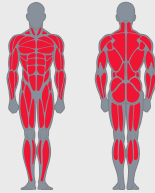

MB 7.38 Lat Pull



PRODUCT SPECIFICATION

	Length	1770 mm
	Width	1800 mm
	Height	2480 mm
	Equipment weight	325 kg
	Maximum load	155 kg
	User height	140 cm
	User age	14 +

TARGET MUSCLES

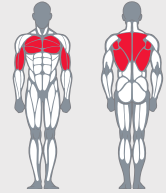

MB 7.37 Standing Row



PRODUCT SPECIFICATION

	Length	1360 mm
	Width	1850 mm
	Height	2060 mm
	Equipment weight	315 kg
	Maximum load	155 kg
	User height	140 cm
	User age	14 +

TARGET MUSCLES

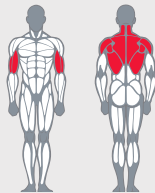

MB 7.39 Biceps Curl



PRODUCT SPECIFICATION

	Length	1660 mm
	Width	2090 mm
	Height	2050 mm
	Equipment weight	245 kg
	Maximum load	75 kg
	User height	140 cm
	User age	14 +

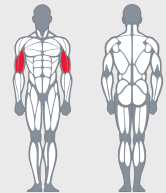

TARGET MUSCLES





MB 7.40 Squat

PRODUCT SPECIFICATION

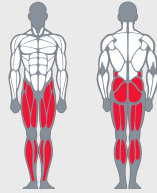

	Length	1800 mm
	Width	1900 mm
	Height	2020 mm
	Equipment weight	345 kg
	Maximum load	155 kg
	User height	140 cm
	User age	14 +

TARGET MUSCLES



MB 7.42 Overhead Triceps

PRODUCT SPECIFICATION

	Length	1320 mm
	Width	2070 mm
	Height	1850 mm
	Equipment weight	335 kg
	Maximum load	95 kg
	User height	140 cm
	User age	14 +

TARGET MUSCLES

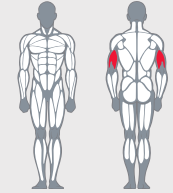

MB 7.41 Combo Lift

PRODUCT SPECIFICATION

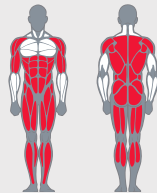

	Length	1670 mm
	Width	1810 mm
	Height	1980 mm
	Equipment weight	345 kg
	Maximum load	155 kg
	User height	140 cm
	User age	14 +

TARGET MUSCLES



MB 7.43 Leg Curl

PRODUCT SPECIFICATION

	Length	1350 mm
	Width	2110 mm
	Height	1840 mm
	Equipment weight	280 kg
	Maximum load	115 kg
	User height	140 cm
	User age	14 +

TARGET MUSCLES

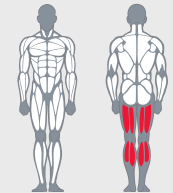

STREET BARBELL GROUP



MB 7.44 Leg Extension

PRODUCT SPECIFICATION

	Length	1350 mm
	Width	2120 mm
	Height	1850 mm
	Equipment weight	280 kg
	Maximum load	155 kg
	User height	140 cm
	User age	14 +

TARGET MUSCLES

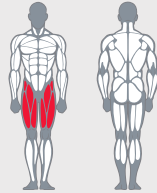

MB 7.46 Rope Pull Down

PRODUCT SPECIFICATION

	Length	1540 mm
	Width	1810 mm
	Height	2430 mm
	Equipment weight	250 kg
	Maximum load	95 kg
	User height	140 cm
	User age	14 +

TARGET MUSCLES

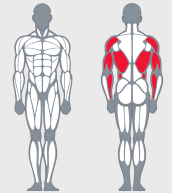

MB 7.45 Standing Glute Press

PRODUCT SPECIFICATION

	Length	1680 mm
	Width	2110 mm
	Height	1780 mm
	Equipment weight	372 kg
	Maximum load	155 kg
	User height	140 cm
	User age	14 +

TARGET MUSCLES

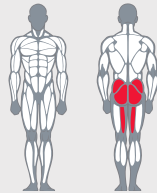

MB 7.47 Multi Workout Station

PRODUCT SPECIFICATION

	Length	3290 mm
	Width	1930 mm
	Height	2640 mm
	Equipment weight	495 kg
	Maximum load	25 kg
	User height	140 cm
	User age	14 +

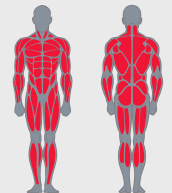

TARGET MUSCLES





MB 7.47/1 Roofless Multi Workout Station

PRODUCT SPECIFICATION

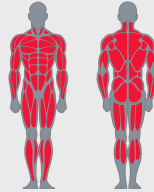

	Length	3620 mm
	Width	1930 mm
	Height	2320 mm
	Equipment weight	475 kg
	Maximum load	25 kg
	User height	140 cm
	User age	14 +

TARGET MUSCLES



MB 7.50 Inner Thigh

PRODUCT SPECIFICATION

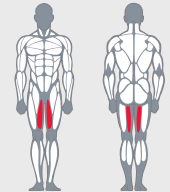

	Length	1720 mm
	Width	1810 mm
	Height	2110 mm
	Equipment weight	390 kg
	Maximum load	155 kg
	User height	140 cm
	User age	14 +

TARGET MUSCLES



MB 7.49 Outer Thigh

PRODUCT SPECIFICATION

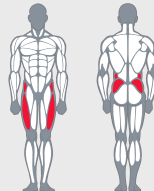

	Length	1920 mm
	Width	1810 mm
	Height	2110 mm
	Equipment weight	390 kg
	Maximum load	155 kg
	User height	140 cm
	User age	14 +

TARGET MUSCLES



MB 7.51 Abdominal Crunch

PRODUCT SPECIFICATION

	Length	1480 mm
	Width	2120 mm
	Height	1920 mm
	Equipment weight	293 kg
	Maximum load	115 kg
	User height	140 cm
	User age	14 +

TARGET MUSCLES

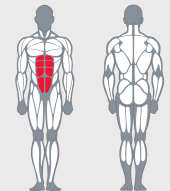

STREET BARBELL GROUP



MB 7.52 Converging Chest Press

PRODUCT SPECIFICATION

	Length	1350 mm
	Width	2150 mm
	Height	2110 mm
	Equipment weight	365 kg
	Maximum load	155 kg
	User height	140 cm
	User age	14 +

TARGET MUSCLES

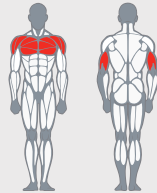

MB 7.54 Convergent Vertical Press

PRODUCT SPECIFICATION

	Length	1350 mm
	Width	1980 mm
	Height	2090 mm
	Equipment weight	280 kg
	Maximum load	115 kg
	User height	140 cm
	User age	14 +

TARGET MUSCLES

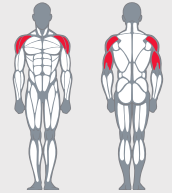

MB 7.53 Divergent Standing Row

PRODUCT SPECIFICATION

	Length	1420 mm
	Width	2080 mm
	Height	2050 mm
	Equipment weight	335 kg
	Maximum load	155 kg
	User height	140 cm
	User age	14 +

TARGET MUSCLES

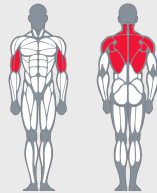

MB 7.55 Divergent Lat Pull

PRODUCT SPECIFICATION

	Length	1620 mm
	Width	1820 mm
	Height	2500 mm
	Equipment weight	280 kg
	Maximum load	155 kg
	User height	140 cm
	User age	14 +

TARGET MUSCLES

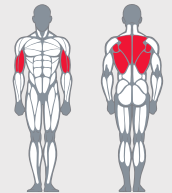

MB 7.48 The Roof



PRODUCT SPECIFICATION

	Length	2790 mm
	Width	1650 mm
	Height	2680 mm
	Equipment weight	215 kg

Reliable protection from rain and the scorching sun. Installed individually above each machine, ensuring comfortable training conditions in any weather



Built-in lighting



Protective pads



High-durability plastic





LIGHT LINE

22 TRAINERS

With advanced biomechanics and a patented load change system, training is easy and convenient

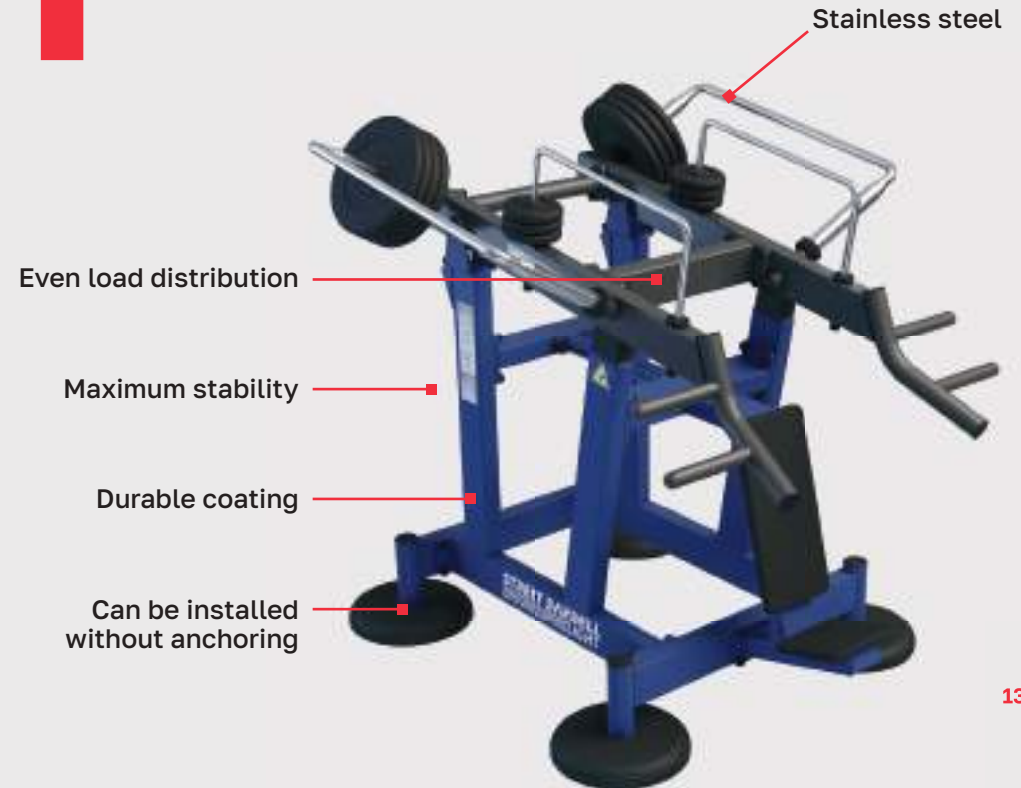

STREET BARBELL GROUP



Watch
the video

MB 7.64 Bench Press



Patented
angled rails



Protective
pads



Video
instructions

PRODUCT SPECIFICATION

	Length	2420 mm
	Width	1400 mm
	Height	1320 mm
	Equipment weight	420 kg
	Maximum load	220 kg
	User height	140 cm
	User age	14 +

TARGET MUSCLES

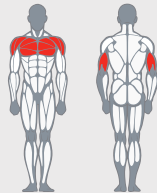

The Street Barbell Light series of trainers is designed for the most convenient training, in almost any installation conditions.

Proper movement mechanics, preventing excessive strain on joints and the spine. Force balancing, ensuring even distribution of pressure across different parts of the machine.





MB 7.61 Combination Exerciser

PRODUCT SPECIFICATION

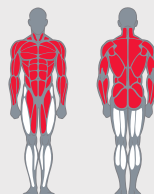

	Length	1800 mm
	Width	1750 mm
	Height	2350 mm
	Equipment weight	150 kg
	Backrest tilt angle	120 °
	Between the bars	655 mm
	User height	140 cm
	User age	14 +

TARGET MUSCLES



MB 7.63 Shoulder Press

PRODUCT SPECIFICATION

	Length	1790 mm
	Width	1500 mm
	Height	1620 mm
	Equipment weight	355 kg
	Maximum load	135 kg
	User height	140 cm
	User age	14 +

TARGET MUSCLES

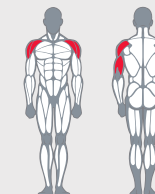

MB 7.62 AB Bench & Hyperextension

PRODUCT SPECIFICATION

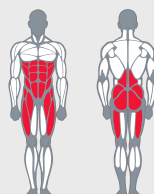

	Length	1390 mm
	Width	1500 mm
	Height	1030 mm
	Equipment weight	130 kg
	Bench angle press	20 °
	Angle of hyperextension	45 °
	User height	140 cm
	User age	14 +

TARGET MUSCLES



MB 7.65 Squat

PRODUCT SPECIFICATION

	Length	1880 mm
	Width	1450 mm
	Height	1610 mm
	Equipment weight	390 kg
	Maximum load	220 kg
	User height	140 cm
	User age	14 +

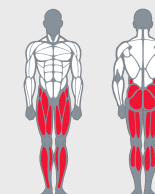

TARGET MUSCLES



MB 7.66 Combo Lift (Dead Lift)



PRODUCT SPECIFICATION

	Length	2050 mm
	Width	1410 mm
	Height	1380 mm
	Equipment weight	390 kg
	Maximum load	220 kg
	User height	140 cm
	User age	14 +

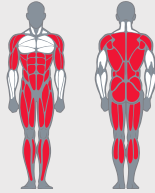

TARGET MUSCLES



MB 7.68 Multi Bar



PRODUCT SPECIFICATION

	Length	2120 mm
	Width	1350 mm
	Height	1680 mm
	Equipment weight	295 kg
	Maximum load	115 kg
	User height	140 cm
	User age	14 +

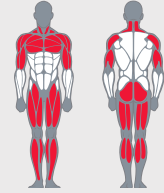

TARGET MUSCLES



MB 7.67 Seated Dips



PRODUCT SPECIFICATION

	Length	2670 mm
	Width	1560 mm
	Height	980 mm
	Equipment weight	310 kg
	Maximum load	115 kg
	User height	140 cm
	User age	14 +

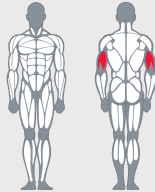

TARGET MUSCLES



MB 7.69 Pull Down Bar



PRODUCT SPECIFICATION

	Length	1410 mm
	Width	1350 mm
	Height	1640 mm
	Equipment weight	160 kg
	Maximum load	40 kg
	User height	140 cm
	User age	14 +

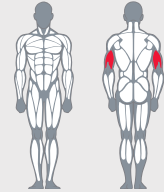

TARGET MUSCLES





MB 7.70 Seated Row

PRODUCT SPECIFICATION

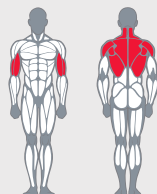

	Length	2090 mm
	Width	1670 mm
	Height	1440 mm
	Equipment weight	240 kg
	Maximum load	75 kg
	User height	140 cm
	User age	14 +

TARGET MUSCLES



MB 7.72 Dumbbell Set (Heavy)

PRODUCT SPECIFICATION

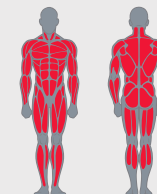

	Length	2130 mm
	Width	2120 mm
	Height	1090 mm
	Equipment weight	200 kg
	Dumbbell weight	14 kg 16 kg 20 kg
	User height	140 cm
	User age	14 +

TARGET MUSCLES



MB 7.71 Dumbbell Set (Light)

PRODUCT SPECIFICATION

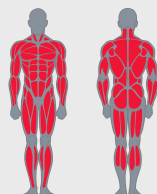

	Length	2130 mm
	Width	2120 mm
	Height	1090 mm
	Equipment weight	160 kg
	Dumbbell weight	8 kg 10 kg 12 kg
	User height	140 cm
	User age	14 +

TARGET MUSCLES



MB 7.74 Leg Press

PRODUCT SPECIFICATION

	Length	2430 mm
	Width	1770 mm
	Height	1530 mm
	Equipment weight	400 kg
	Maximum load	140 kg
	User height	140 cm
	User age	14 +

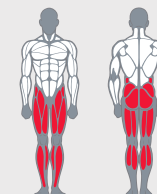

TARGET MUSCLES





MB 7.75 Incline Bench Press at a 45-Degree Angle

PRODUCT SPECIFICATION

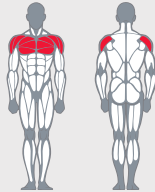

	Length	2010 mm
	Width	1500 mm
	Height	1750 mm
	Equipment weight	375 kg
	Maximum load	135 kg
	User height	140 cm
	User age	14 +

TARGET MUSCLES



MB 7.79 Flat Bench Press

PRODUCT SPECIFICATION

	Length	2920 mm
	Width	1350 mm
	Height	1780 mm
	Equipment weight	440 kg
	Maximum load	155 kg
	User height	140 cm
	User age	14 +

TARGET MUSCLES

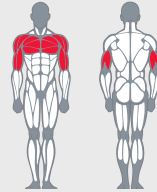

MB 7.76 Leg Extension

PRODUCT SPECIFICATION

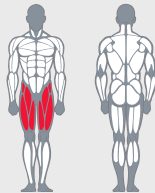

	Length	1490 mm
	Width	1780 mm
	Height	1280 mm
	Equipment weight	260 kg
	Maximum load	60 kg
	User height	140 cm
	User age	14 +

TARGET MUSCLES



MB 7.85 Glute Bridge

PRODUCT SPECIFICATION

	Length	1860 mm
	Width	1740 mm
	Height	1240 mm
	Equipment weight	316 kg
	Maximum load	50 kg
	User height	140 cm
	User age	14 +

TARGET MUSCLES

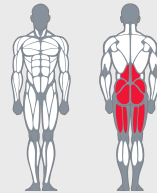



MB 7.86 Pendulum Squat

PRODUCT SPECIFICATION

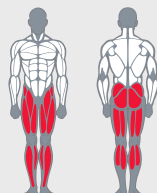

	Length	1960 mm
	Width	1980 mm
	Height	1880 mm
	Equipment weight	440 kg
	Maximum load	140 kg
	User height	140 cm
	User age	14 +

TARGET MUSCLES



MB 7.88 Adjustable Hyperextension Machine

PRODUCT SPECIFICATION

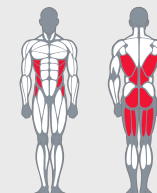

	Length	1730 mm
	Width	1350 mm
	Height	1170 mm
	Equipment weight	125 kg
	Maximum load	20 kg
	User height	140 cm
	User age	14 +

TARGET MUSCLES



MB 7.87 Leg Curl Machine

PRODUCT SPECIFICATION

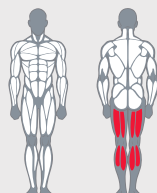

	Length	1550 mm
	Width	1560 mm
	Height	1000 mm
	Equipment weight	200 kg
	Maximum load	30 kg
	User height	140 cm
	User age	14 +

TARGET MUSCLES



MB 7.89 Seated Leg Curl Machine

PRODUCT SPECIFICATION

	Length	1480 mm
	Width	1560 mm
	Height	1350 mm
	Equipment weight	210 kg
	Maximum load	30 kg
	User height	140 cm
	User age	14 +

TARGET MUSCLES

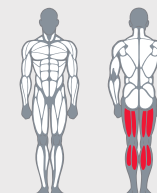



STREET BARBELL GROUP

MB 7.73 Assisted Pull-Ups + Triceps Dips



PRODUCT SPECIFICATION

	Length	2640 mm
	Width	1750 mm
	Height	2340 mm
	Equipment weight	206 kg
	Maximum counterweight	80 kg
	User height	140 cm
	User age	14 +

TARGET MUSCLES

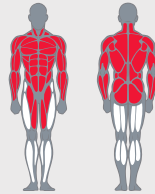

Patented weight system

Anti-slip steps

Counterweight



PLUS LINE

9 TRAINERS

Engineered to accommodate the specific needs of wheelchair users



STREET BARBELL GROUP









Watch
the video

MB 7.29.3 Shoulder Press



PRODUCT SPECIFICATION

	Length	1800 mm
	Width	1580 mm
	Height	1750 mm
	Equipment weight	378 kg
	Maximum load	87,5 kg
	User height	140 cm
	User age	14 +

TARGET MUSCLES

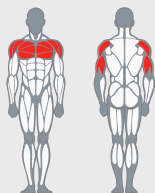

These exercise machines are uniquely designed with a non-removable folding seat, allowing wheelchair users to train comfortably.



Patented
weight system



Folding seat





Video
instructions





MB 7.30.3 Chest Press

PRODUCT SPECIFICATION

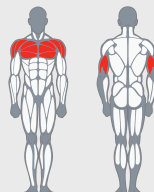

	Length	1800 mm
	Width	1580 mm
	Height	1830 mm
	Equipment weight	318 kg
	Maximum load	87,5 kg
	User height	140 cm
	User age	14 +

TARGET MUSCLES



MB 7.37.3 Row

PRODUCT SPECIFICATION

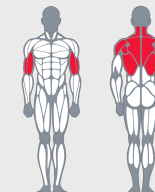

	Length	1700 mm
	Width	1580 mm
	Height	2000 mm
	Equipment weight	338 kg
	Maximum load	87,5 kg
	User height	140 cm
	User age	14 +

TARGET MUSCLES



MB 7.31.3 Butterfly

PRODUCT SPECIFICATION

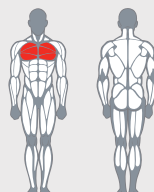

	Length	1830 mm
	Width	1580 mm
	Height	1980 mm
	Equipment weight	358 kg
	Maximum load	87,5 kg
	User height	140 cm
	User age	14 +

TARGET MUSCLES



MB 7.38.3 Lat Pull

PRODUCT SPECIFICATION

	Length	1740 mm
	Width	1580 mm
	Height	2100 mm
	Equipment weight	368 kg
	Maximum load	87,5 kg
	User height	140 cm
	User age	14 +

TARGET MUSCLES

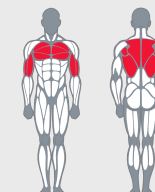



STREET BARBELL GROUP



MB 7.39.3 Biceps Curl

PRODUCT SPECIFICATION

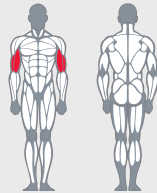

	Length	1580 mm
	Width	1580 mm
	Height	1830 mm
	Equipment weight	358 kg
	Maximum load	87,5 kg
	User height	140 cm
	User age	14 +

TARGET MUSCLES



MB 7.47.3 Multi Trainer

PRODUCT SPECIFICATION

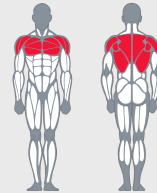

	Length	2020 mm
	Width	1470 mm
	Height	2150 mm
	Equipment weight	140 kg
	User height	140 cm
	User age	14 +

TARGET MUSCLES



MB 7.42.3 Triceps

PRODUCT SPECIFICATION

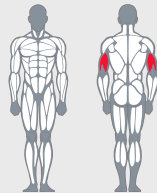

	Length	1820 mm
	Width	1580 mm
	Height	1830 mm
	Equipment weight	496 kg
	Maximum load	87,5 kg
	User height	140 cm
	User age	14 +

TARGET MUSCLES



MB 7.56.3 Incline Chest Press

PRODUCT SPECIFICATION

	Length	1820 mm
	Width	1580 mm
	Height	2000 mm
	Equipment weight	377 kg
	Maximum load	87,5 kg
	User height	140 cm
	User age	14 +

TARGET MUSCLES

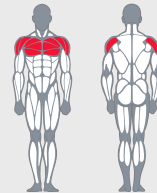



STREET BARBELL GROUP

DISCOVER THE UNIQUENESS THAT SETS US APART

Street Barbell's primary uniqueness lies in our exclusive adjustable weight feature, making outdoor training accessible and customizable for users of all fitness levels.

In 2016, our StreetBarbell machines with variable loads were nominated for the Innovation Award at FIBO, Europe's largest sports industry and fitness exhibition held in Cologne, Germany. The same year, StreetBarbell machines earned a spot in the Top 10 Fitness Trends in Europe, as recognized by the German magazine BILD.de.



PRO LINE

12 TRAINERS

Advanced trainers with cutting-edge technology and precise biomechanics for maximum efficiency, comfort, and durability





STREET BARBELL GROUP

MB 7.90 Adjustable Resistance Multi-Station



PRODUCT SPECIFICATION

	Length	2900 mm
	Width	1730 mm
	Height	1990 mm
	Equipment weight	505 kg
	Maximum load	270 kg
	User height	140 cm
	User age	14 +

TARGET MUSCLES



The Street Barbell Pro series of trainers is designed for maximum efficiency and durability, ensuring reliable performance in any installation conditions. Durability and stability of the machine even under heavy loads.



Patented weight system

Easy adjustment



Instructions





MB 7.94 Adjustable Hyperextension Bench

PRODUCT SPECIFICATION

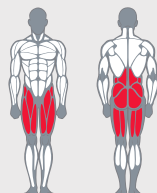

	Length	1970 mm
	Width	1750 mm
	Height	1580 mm
	Equipment weight	300 kg
	Maximum load	12,5 kg
	User height	140 cm
	User age	14 +

TARGET MUSCLES



MB 7.96 Pullover

PRODUCT SPECIFICATION

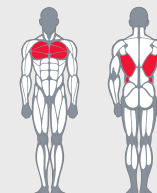

	Length	1930 mm
	Width	1960 mm
	Height	1380 mm
	Equipment weight	450 kg
	Maximum load	120 kg
	User height	140 cm
	User age	14 +

TARGET MUSCLES



MB 7.95 Bench Press with U-Shaped Bar

PRODUCT SPECIFICATION

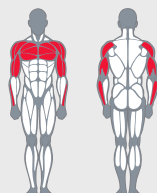

	Length	2250 mm
	Width	1820 mm
	Height	1430 mm
	Equipment weight	430 kg
	Maximum load	155 kg
	User height	140 cm
	User age	14 +

TARGET MUSCLES



MB 7.98 Triceps Rope Pushdown

PRODUCT SPECIFICATION

	Length	1700 mm
	Width	1350 mm
	Height	1760 mm
	Equipment weight	320 kg
	Maximum load	115 kg
	User height	140 cm
	User age	14 +

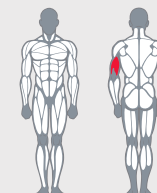

TARGET MUSCLES



STREET BARBELL GROUP

MB 7.100 Crossover

PRODUCT SPECIFICATION

	Length	5120 mm
	Width	1350 mm
	Height	2340 mm
	Equipment weight	790 kg
	Maximum load	115x2 kg
	User height	140 cm
	User age	14 +

TARGET MUSCLES

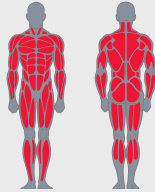

MB 7.102 Vertical Pull

PRODUCT SPECIFICATION

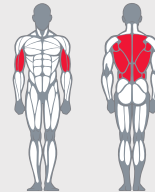

	Length	2130 mm
	Width	1350 mm
	Height	2270 mm
	Equipment weight	450 kg
	Maximum load	155 kg
	User height	140 cm
	User age	14 +

TARGET MUSCLES



MB 7.101 Horizontal Pull

PRODUCT SPECIFICATION

	Length	2900 mm
	Width	1350 mm
	Height	2220 mm
	Equipment weight	460 kg
	Maximum load	155 kg
	User height	140 cm
	User age	14 +

TARGET MUSCLES

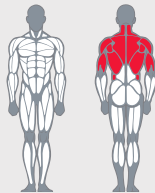

MB 7.103 Inclined Leverage Row

PRODUCT SPECIFICATION

	Length	2140 mm
	Width	1350 mm
	Height	1840 mm
	Equipment weight	390 kg
	Maximum load	155 kg
	User height	140 cm
	User age	14 +

TARGET MUSCLES

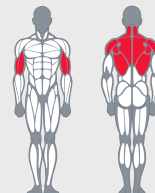



MB 7.108 Seated Row

PRODUCT SPECIFICATION

	Length	2095 mm
	Width	1670 mm
	Height	1440 mm
	Equipment weight	245 kg
	Maximum load	195 kg
	User height	140 cm
	User age	14 +

TARGET MUSCLES

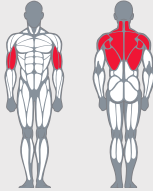

MB 7.113 Cable Machine

PRODUCT SPECIFICATION

	Length	2060 mm
	Width	1350 mm
	Height	2380 mm
	Equipment weight	430 kg
	Maximum load	115 kg
	User height	140 cm
	User age	14 +

TARGET MUSCLES

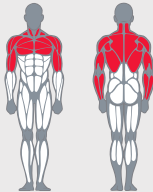

**MB 7.61
COMBINED
EXERCISER**



PULL-UPS



LAT
PULL-DOWN



CHEST
PRESS

STREET BARBELL
ACTIVE FITNESS GROUP

Street Barbell Group OF
Gyrfelshelmska 4, 103 61
Helsinki Finland

info@streetbarbell.com
www.streetbarbell.com

STREET BARBELL
ACTIVE FITNESS GROUP



TO GET
THE TUTORIAL
FOR THIS TRAINER
PLEASE SCAN
THIS CODE



**SAFE
TRAINING
VIDEO
GUIDE**

Our trainers are reliable and safe, with clear and accessible guidance.

Street Barbell trainers are equipped with information signs with exercise options, safety recommendations and manufacturer contact information for inquiries.

As well as QR codes that lead users to YouTube video lessons from professional trainers.

BOXING

LINE

3 TRAINERS

Reinforced design and impact-resistant materials ensure durability, safety, and comfort



STREET BARBELL GROUP

MB 7.91 Heavy punching bag stand



Weather-resistant materials



Stable construction



Designed for impact training

PRODUCT SPECIFICATION

	Length	2180 mm
	Width	1550 mm
	Height	2540 mm
	Equipment weight	140 kg

Bag size:

Length	340 mm
Width	340 mm
Height	1650 mm
Equipment weight	40 kg

	User height	140 cm
	User age	16 +

The Street Barbell Boxing series is a set of popular boxing shells – bags, punch balls, various pillows for practicing punches.

Boxing bags are specially designed for outdoor use. Reinforced PVC fabric is resistant to the environmental influence, has special elasticity and perfectly retains its properties at temperatures from -30 to +70 degrees.





MB 7.92 Heavy Punching Bag Stand

PRODUCT SPECIFICATION

	Length	2180 mm
	Width	1550 mm
	Height	2540 mm
	Equipment weight	140 kg

Bag size:

Length	590 mm
Width	590 mm
Height	850 mm
Weight	40 kg

	User height	140 cm
	User age	16 +

MB 7.93 Multi Station Punching Bag Stand

PRODUCT SPECIFICATION

	Length	4100 mm
	Width	4100 mm
	Height	2750 mm
	Equipment weight	510 kg

Bags size:

Length	340	590	340 mm
Width	340	590	340 mm
Height	1650	850	1650 mm
Weight	40	40	15 kg

	User height	140 cm
	User age	16 +





WORKOUT LINE

19 TRAINERS

A combination of innovation, reliability, and convenience for effective training in any environment





STREET BARBELL GROUP

MB 7.60/1 Horizontal ladder (Type A)



PRODUCT SPECIFICATION

	Length	10220 mm
	Width	5970 mm
	Height	2520 mm
	Equipment weight	1186 kg
	User height	140 cm
	User age	14 +

The Street Workout Line includes a set of crossbars, bars, handlebars, wall bars and other elements for pull-ups and push-ups. The complex was developed together with the worldwide workout founders and includes everything necessary for training fans of this type of street sports.



Reliable fastenings



Durable handrails



Steel posts





MB 7.60/2 Horizontal ladder (Type B)

PRODUCT SPECIFICATION

	Length	10220 mm
	Width	4650 mm
	Height	2520 mm
	Equipment weight	671 kg

	User height	140 cm
	User age	14 +

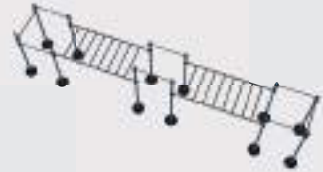

MB 7.60/3 Horizontal ladder (Type C)

PRODUCT SPECIFICATION

	Length	10220 mm
	Width	1720 mm
	Height	2520 mm
	Equipment weight	568 kg

	User height	140 cm
	User age	14 +



MB 7.60/4 Wall Bars

PRODUCT SPECIFICATION

	Length	5700 mm
	Width	1720 mm
	Height	2520 mm
	Equipment weight	540 kg

	User height	140 cm
	User age	14 +



MB 7.60/5 Low level Parallel Bars

PRODUCT SPECIFICATION

	Length	1720 mm
	Width	1040 mm
	Height	470 mm
	Equipment weight	68 kg

	User height	140 cm
	User age	14 +



MB 7.60/6 Parallel Bars

PRODUCT SPECIFICATION

	Length	2420 mm
	Width	1040 mm
	Height	1620 mm
	Equipment weight	82 kg

	User height	140 cm
	User age	14 +



MB 7.60/7 Australian Pull Up Bars

PRODUCT SPECIFICATION

	Length	1730 mm
	Width	400 mm
	Height	1620 1070 470 mm
	Equipment weight	134 kg

	User height	140 cm
	User age	14 +

STREET BARBELL GROUP



MB 7.60/8 Pull Up Bars Set

PRODUCT SPECIFICATION

	Length	3050 mm
	Width	3050 mm
	Height	2520 mm
	Equipment weight	382 kg
	User height	140 cm
	User age	14 +



MB 7.60/9 Uneven Pull Up and Parallel Bars

PRODUCT SPECIFICATION

	Length	2420 mm
	Width	2220 mm
	Height	2520 mm
	Equipment weight	166 kg
	User height	140 cm
	User age	14 +



MB 7.60/10 Combined Wall, Pull and Parallel Bars

PRODUCT SPECIFICATION

	Length	3740 mm
	Width	2220 mm
	Height	2520 mm
	Equipment weight	200 kg
	User height	140 cm
	User age	14 +



MB 7.60/11 Horizontal ladder (Type D)



PRODUCT SPECIFICATION

	Length	4650 mm
	Width	1720 mm
	Height	2520 mm
	Equipment weight	230 kg
	User height	140 cm
	User age	14 +



MB 7.60/12 Combined Horizontal Ladder, Wall And Uneven Pull Up

PRODUCT SPECIFICATION

	Length	6580 mm
	Width	1900 mm
	Height	2520 mm
	Equipment weight	320 kg
	User height	140 cm
	User age	14 +





MB 7.60/13 Horizontal ladder (Type E)

PRODUCT SPECIFICATION

	Length	3320 mm
	Width	1720 mm
	Height	2520 mm
	Equipment weight	140 kg
	User height	140 cm
	User age	14 +

MB 7.60/14 Horizontal ladder (Type F)
PRODUCT SPECIFICATION

	Length	6250 mm
	Width	1720 mm
	Height	2520 mm
	Equipment weight	254 kg

	User height	140 cm
	User age	14 +

MB 7.60/15 Combined Pull Up and Wall Bars
PRODUCT SPECIFICATION

	Length	1720 mm
	Width	1720 mm
	Height	2520 mm
	Equipment weight	135 kg

	User height	140 cm
	User age	14 +

MB 7.60/16 Horizontal ladder (Type G)
PRODUCT SPECIFICATION

	Length	4650 mm
	Width	1720 mm
	Height	2520 mm
	Equipment weight	266 kg

	User height	140 cm
	User age	14 +

MB 7.60/17 Horizontal ladder (Type H)
PRODUCT SPECIFICATION

	Length	6670 mm
	Width	1720 mm
	Height	2520 mm
	Equipment weight	340 kg

	User height	140 cm
	User age	14 +

MB 7.60/18 Three Level Pull Up Bars
PRODUCT SPECIFICATION

	Length	3050 mm
	Width	1720 mm
	Height	2520 mm
	Equipment weight	136 kg

	User height	140 cm
	User age	14 +

MB 7.60/19 Wall Bars
PRODUCT SPECIFICATION

	Length	3050 mm
	Width	1720 mm
	Height	2520 mm
	Equipment weight	155 kg

	User height	140 cm
	User age	14 +

STREET BARBELL GROUP

Crafted for Endurance

Despite their seemingly simple design, outdoor trainers require elevated standards of reliability and safety due to their exposure to harsh outdoor conditions, including weather, vandalism, and minimal maintenance.

Street Barbell's commitment to quality is evident in our choice of materials, including robust rubberized steel discs and one-piece steel pipes. Our trainers are equipped with sealed bearings, the backs and seats are made of high-strength polyurethane.



GYMNASTIC LINE

17 TRAINERS

Ideal for workouts,
stretching, warm-ups,
muscle toning, and
cardio training

Vandal-resistant design

Durable coating

Ease of use

Versatility

Safety of use



STREET BARBELL GROUP

MB 7.02 Walker



Non-slip Pedal









Maintenance-free sealed bearings



Ergonomic handles

PRODUCT SPECIFICATION

	Length	1210 mm
	Width	550 mm
	Height	1320 mm
	Equipment weight	64 kg
	User height	140 cm
	User age	14 +

TARGET MUSCLES

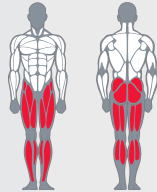

Gymnastic Line— bodyweight fitness equipment using as well aerobic load. They are perfect for workout, stretching, warming up before performing more complex physical exercises, for maintaining muscle tone and cardio training. Due to their biomechanics, they do not load the joints and can be used by people of different age and levels of physical fitness.





MB 7.03 Combined Pull Down and Leg Raise Station

PRODUCT SPECIFICATION

	Length	1530 mm
	Width	1220 mm
	Height	1890 mm
	Equipment weight	90 kg

TARGET MUSCLES

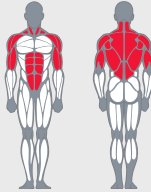

	User height	140 cm
	User age	14 +

MB 7.04 Rider

PRODUCT SPECIFICATION

	Length	1230 mm
	Width	750 mm
	Height	1280 mm
	Equipment weight	45 kg

TARGET MUSCLES

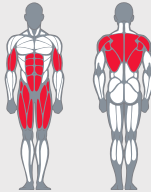

	User height	140 cm
	User age	14 +

MB 7.05 Combined Exerciser

PRODUCT SPECIFICATION

	Length	1030 mm
	Width	1200 mm
	Height	2410 mm
	Equipment weight	56 kg

TARGET MUSCLES

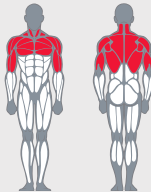

	User height	140 cm
	User age	14 +



MB 7.06 Leg Press

PRODUCT SPECIFICATION

	Length	1800 mm
	Width	440 mm
	Height	1700 mm
	Equipment weight	65 kg

TARGET MUSCLES

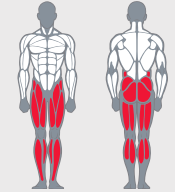

	User height	140 cm
	User age	14 +

MB 7.07 Pendulum

PRODUCT SPECIFICATION

	Length	1030 mm
	Width	750 mm
	Height	1420 mm
	Equipment weight	60 kg

TARGET MUSCLES

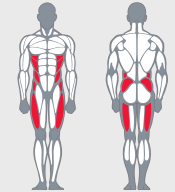

	User height	140 cm
	User age	14 +

MB 7.08 Stepper

PRODUCT SPECIFICATION

	Length	1050 mm
	Width	750 mm
	Height	1570 mm
	Equipment weight	74 kg

TARGET MUSCLES

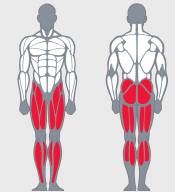



	User height	140 cm
	User age	14 +

STREET BARBELL GROUP



MB 7.09 Twister

PRODUCT SPECIFICATION

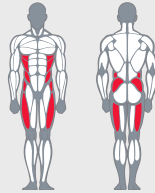

	Length	1330 mm
	Width	460 mm
	Height	1290 mm
	Equipment weight	46 kg
	User height	140 cm
	User age	14 +

TARGET MUSCLES



MB 7.13 Sit Up Bench Hyperextension

PRODUCT SPECIFICATION

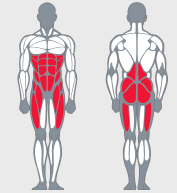

	Length	1190 mm
	Width	1370 mm
	Height	910 mm
	Equipment weight	73 kg
	User height	140 cm
	User age	14 +

TARGET MUSCLES



MB 7.10 Rower

PRODUCT SPECIFICATION

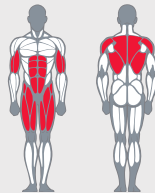

	Length	1390 mm
	Width	880 mm
	Height	800 mm
	Equipment weight	56 kg
	User height	140 cm
	User age	14 +

TARGET MUSCLES



MB 7.14 Inverse Hyperextension

PRODUCT SPECIFICATION

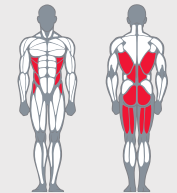

	Length	780 mm
	Width	600 mm
	Height	1080 mm
	Equipment weight	40 kg
	User height	140 cm
	User age	14 +

TARGET MUSCLES



MB 7.11 Ski Walker

PRODUCT SPECIFICATION

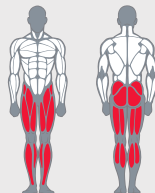

	Length	770 mm
	Width	570 mm
	Height	1510 mm
	Equipment weight	60 kg
	User height	140 cm
	User age	14 +

TARGET MUSCLES



MB 7.15 Parallel Bars

PRODUCT SPECIFICATION

	Length	1330 mm
	Width	880 mm
	Height	1360 mm
	Equipment weight	76 kg
	User height	140 cm
	User age	14 +

TARGET MUSCLES

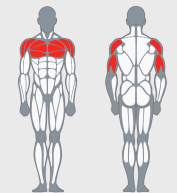



MB 7.22 Legs Spreading

PRODUCT SPECIFICATION

	Length	1140 mm
	Width	490 mm
	Height	1430 mm
	Equipment weight	68 kg

	User height	140 cm
	User age	14 +

TARGET MUSCLES

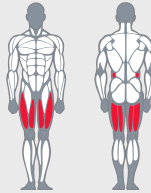

MB 7.26 Lat Pull Down

PRODUCT SPECIFICATION

	Length	1840 mm
	Width	1190 mm
	Height	1890 mm
	Equipment weight	101 kg

	User height	140 cm
	User age	14 +

TARGET MUSCLES

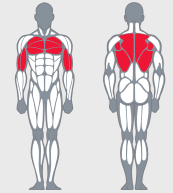

MB 7.23 Chest Press

PRODUCT SPECIFICATION

	Length	1540 mm
	Width	1060 mm
	Height	2130 mm
	Equipment weight	122 kg

	User height	140 cm
	User age	14 +

TARGET MUSCLES

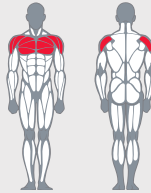

MB 7.24 Abdominal On The Swing

PRODUCT SPECIFICATION

	Length	970 mm
	Width	1510 mm
	Height	1640 mm
	Equipment weight	110 kg
	Maximum load	15 kg

	User height	140 cm
	User age	14 +

TARGET MUSCLES

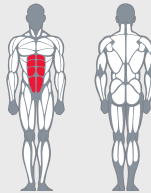



STREET BARBELL GROUP

PRIORITIZING SAFETY: OUR FOUNDATIONAL COMMITMENT

Safety is a paramount concern for our outdoor trainers. It involves both technological design and biomechanics.

During the design phase, factors like angles, grip placement, components, and structural elements are carefully considered in relation to user activities. A well-designed trainer should prevent user injuries and premature malfunctions.

Street Barbell, with its expertise and technological capabilities, produces reliable and safe trainers. Our trainers undergo rigorous testing, and we collaborate with TÜV THÜRINGEN experts to ensure they meet the highest safety and quality standards.



KIDS LINE

7 TRAINERS

The equipment is safe for kids, suitable for stretching, cardio and sports activities



STREET BARBELL GROUP

MB 7.02 Walker For Kids



Non-slip Pedal



Maintenance-free sealed bearings



Ergonomic handles



Length	1000 mm
Width	425 mm
Height	920 mm
Equipment weight	64 kg



User height	100 cm
User age	6 +

TARGET MUSCLES

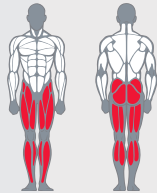

The Kids Line is a bodyweight and aerobic fitness equipment for children.



Equipment have reduced dimensions, and their biomechanics take into account the anatomical features of small athletes. Trainers are safe for children, and they are perfect for workouts, stretching, warming up, maintaining muscle tone and cardio training.





MB 7.06.1 Leg Press For Kids

PRODUCT SPECIFICATION

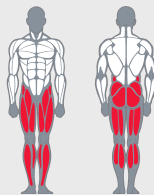

	Length	1340 mm
	Width	370 mm
	Height	1220 mm
	Equipment weight	65 kg
	User height	100 cm
	User age	6 +

TARGET MUSCLES



MB 7.09.1 Twister For Kids

PRODUCT SPECIFICATION

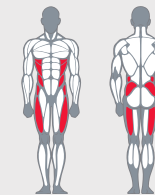

	Length	1030 mm
	Width	340 mm
	Height	850 mm
	Equipment weight	32 kg
	User height	100 cm
	User age	6 +

TARGET MUSCLES



MB 7.07.1 Pendulum For Kids

PRODUCT SPECIFICATION

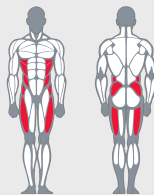

	Length	1000 mm
	Width	510 mm
	Height	1030 mm
	Equipment weight	47 kg
	User height	100 cm
	User age	6 +

TARGET MUSCLES



MB 7.11.1 Ski Walker For Kids

PRODUCT SPECIFICATION

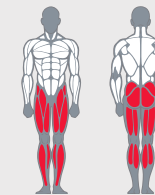

	Length	630 mm
	Width	530 mm
	Height	1070 mm
	Equipment weight	55 kg
	User height	100 cm
	User age	6 +

TARGET MUSCLES



MB 7.08.1 Stepper For Kids

PRODUCT SPECIFICATION

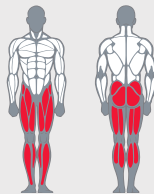

	Length	780 mm
	Width	560 mm
	Height	1150 mm
	Equipment weight	53 kg
	User height	100 cm
	User age	6 +

TARGET MUSCLES



MB 7.22.1 Legs Spreading For Kids

PRODUCT SPECIFICATION

	Length	920 mm
	Width	370 mm
	Height	1100 mm
	Equipment weight	60 kg
	User height	100 cm
	User age	6 +

TARGET MUSCLES

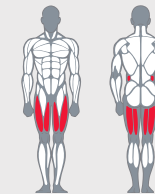



STREET BARBELL GROUP

StreetBarbell Coating Systems

StreetBarbell utilizes three advanced coating methods to ensure superior durability, corrosion resistance, and mechanical protection for metal components.

1. Hot Dip Galvanization System

The hot dip galvanization process forms a robust zinc protective layer, providing exceptional resistance to corrosion and mechanical damage. This process involves submerging metal in molten zinc, creating a long-lasting anti-corrosion coating.

Advantages:

- High resistance to corrosion and oxidation.
- Strong adhesion and protection against mechanical damage.
- Self-healing properties for minor scratches and abrasions.
- Minimal maintenance requirements.

Processing Steps:

1. Metal preparation and shot blasting for surface cleaning.
2. Immersion in molten zinc to form a durable coating.
3. Surface grinding for a uniform finish.
4. Final powder coating application for enhanced aesthetics and additional protection.

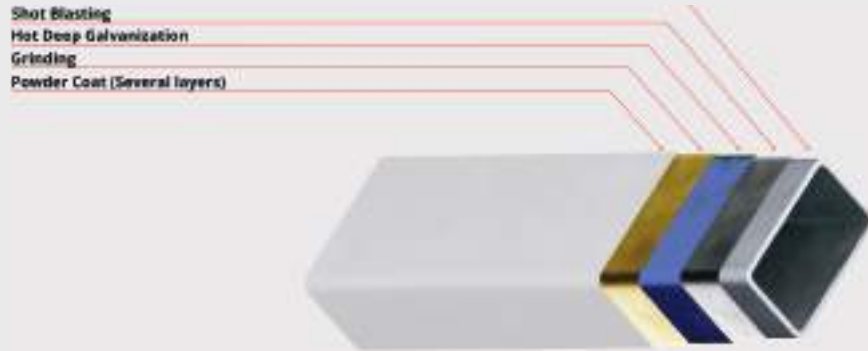

2. Powder Coating System

The powder coating process provides a smooth, wear-resistant finish that protects metal components from external elements while maintaining an attractive appearance.

Coating Specifications:

- Applied at a thickness of 200 microns and above.
- Resistant to chipping, wear, and UV exposure.

Processing Steps:

1. Sandblasting to remove impurities and ensure strong adhesion.
2. Surface degreasing and application of a high-zinc primer for enhanced corrosion resistance.
3. Application of multiple layers of powder coating for a uniform and durable finish.



STREET BARBELL GROUP

3. Thermoplastic Coating System

The thermoplastic coating process creates a flexible yet highly durable protective layer, resistant to impacts, chemicals, and environmental exposure.

Advantages:

- Exceptional durability and resistance to mechanical stress.
- Non-porous barrier against moisture, chemicals, and oxidation.
- Environmentally friendly: solvent-free and recyclable.

Processing Steps:

1. Shot blasting and degreasing for surface preparation.
2. Preheating the metal to improve powder adhesion.
3. Application of thermoplastic powder using electrostatic or fluidized bed techniques.
4. Post-baking (if necessary) to ensure full bonding and durability.

With these advanced coating methods, StreetBarbell guarantees superior reliability, longevity, and protection for metal components in any application.

Shot blasting

Surface degreasing

Surface heating

Thermoplastic Coat (Several layers)





CARDIO LINE

NEW CARDIO LINE

Compact size

Unique design

Innovative resistance system





Design as an identity

The new recumbent bike is the result of a collaboration with Ciclotte and designer Luca Schieppati, combining unique style and innovative solutions.

The design incorporates key aesthetic elements from the current Ciclotte model, maintaining its signature exclusivity.

The frame consists of two side sections and features an open circular shape, emphasizing the elegance of the construction.

The pedals follow the original concept: they are enlarged and reinforced to withstand any stress in outdoor conditions.

The grip profile reflects Ciclotte's distinctive style, while the analogous base structure reinforces the brand's recognizable identity.

Recumbent Bike



STREET BARBELL GROUP

UPRIGHT BIKE





**STREET BARBELL –
OUTDOOR FITNESS FOR
THE WHOLE FAMILY**



STREET BARBELL
LIGHT