

# Product Catalog

Gym Accessories, Racks and Rigs



**Gymleco**



"Our mission is to make not only Sweden, but the world, healthier, stronger and more sustainable."

**- Kari Jernvall**  
*Founder and Product Designer*

# Welcome

## Welcome to the Gymleco Family

Gymleco is a Swedish, family-owned company driven by a passion for health, strength, innovation, and sustainability. Today, we are one of Europe's leading designers and manufacturers of strength training equipment.

With customers worldwide, Gymleco has grown into a trusted gym machine brand known for innovative design and biomechanical precision. We offer a complete range of strength training and exercise equipment, and we are among the few manufacturers in the Nordics producing our equipment in-house.

We aim to be more than a supplier. We strive to be a total solution and a profitable, long-term investment for our customers.

Since 1994, Gymleco has focused on developing Swedish-made equipment that is functional, durable, and built for a long lifespan with minimal maintenance. We are truly passionate about fitness, and we invite you to join us in our ambition for a healthier world and a more sustainable future.

## Why choose Gymleco?

- Decades of experience
- Biomechanical precision
- Innovative, original design
- Low maintenance
- Commercial-grade quality use
- Space-efficient footprint
- Suitable for all users
- Ergonomically correct movement
- Affordable quality

# Contents

<b>Barbells, Weight Plates &amp; Dumbbells</b>	8
<b>Cable Handles &amp; Small Equipment</b>	24
<b>Mats, Balls &amp; Boxes</b>	28
<b>Storage, Racks &amp; Rigs</b>	34
<b>Functional Strength</b> <i>Calisthenics, Strongman &amp; Functional Fitness</i>	46
<b>Gymleco Distributors</b>	54



# Accessories

Are you a gym owner looking for gym gear that's built to last? Then you've come to the right place. Gymleco equipment is manufactured to the highest commercial standards, making it ideal for professional gyms that demand durable, long-lasting products.

Gymleco accessories cover a wide range of high-quality essentials for professional training environments. In this catalogue you'll find everything from barbells and weight plates to storage solutions, racks, and rigs — everything you need to build a complete gym.

*Read more about our products at [gymleco.com](https://gymleco.com)*

**Open Deadlit Bar, 10 kg /+300 kg**  
Art.nr: 408

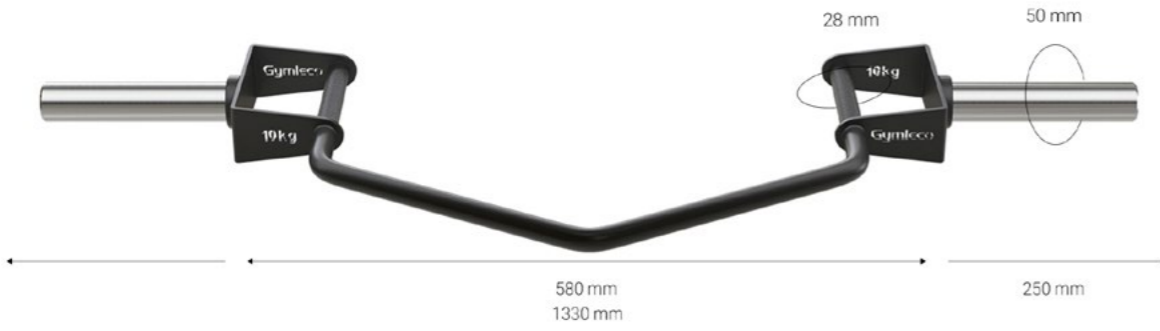

**Triceps/Biceps Bar, Double V-Grip, 12,5 kg / +150 kg**  
Art.nr: 413V

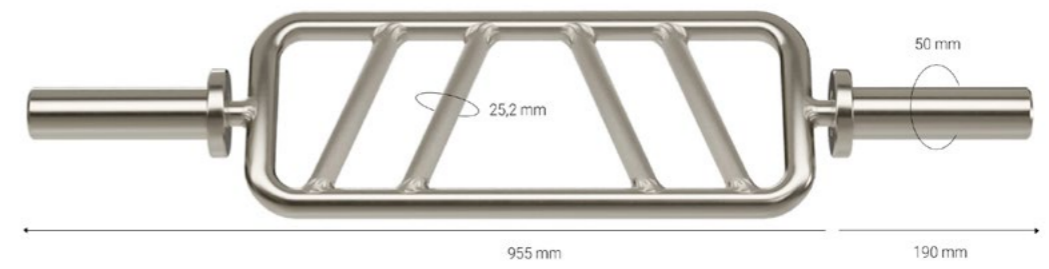

**Olympic Barbell 20 kg /+315 kg**  
Art.nr: 410

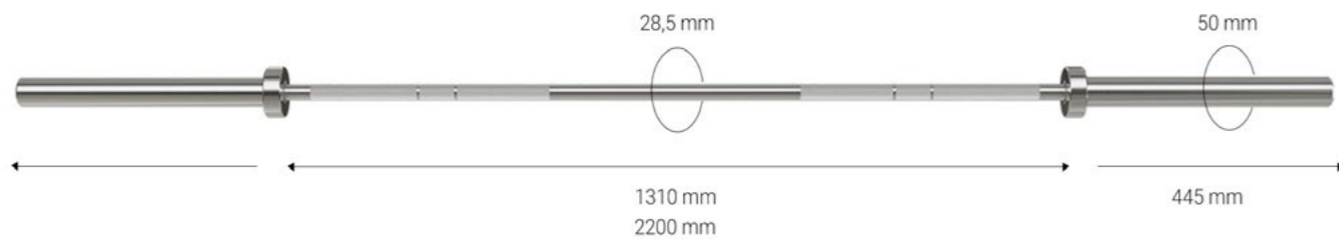

**Competition Powerlifting Bar, 20 kg /+900 kg**  
Art.nr: 414

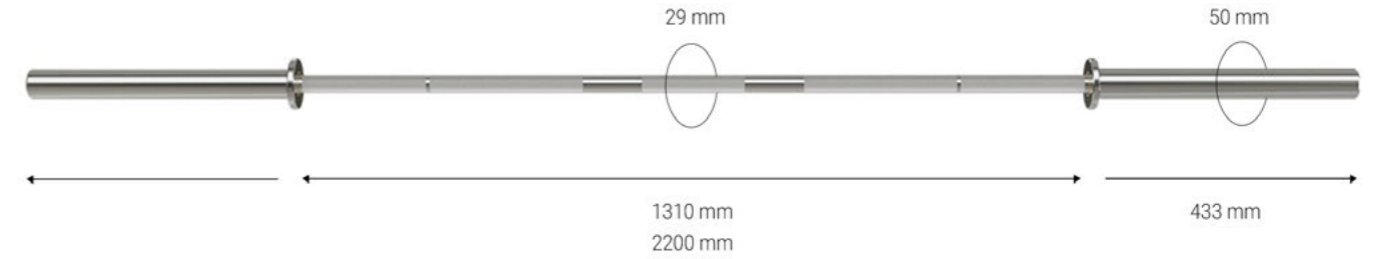

**Competition Powerlifting Bar, Black, 20 kg /+900 kg**  
Art.nr: 411



**Curl Bar, 10 kg /+180 kg**  
Art.nr: 415



**Compact Bar 200 cm, 17 kg /+320 kg**  
Art.nr: 412

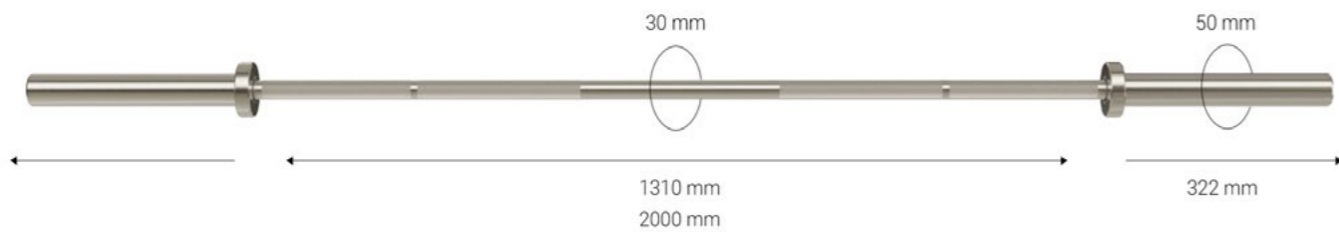

**Super Curl Bar, 10 kg /+180 kg**  
Art.nr: 415S



**Triceps Bar, Double Grip, 12,5 kg /+150 kg**  
Art.nr: 413

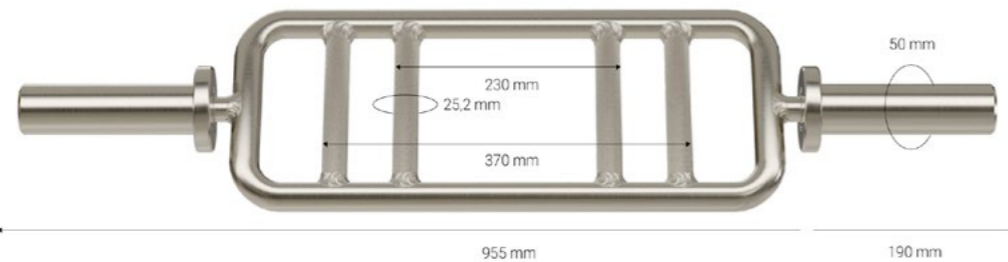

**Precision Curl Bar 12 kg /+180 kg**  
Art.nr: 415E



**Supra Curl Bar 10,4 kg / +150 kg**

Art.nr: 415Q

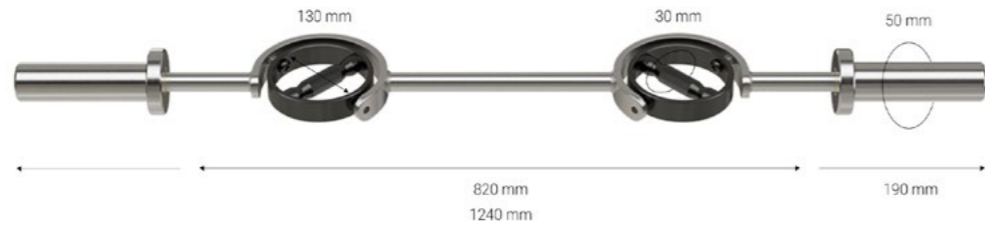

**Short Gym Bar, 153 cm, 11 kg /+315 kg**

Art.nr: 416

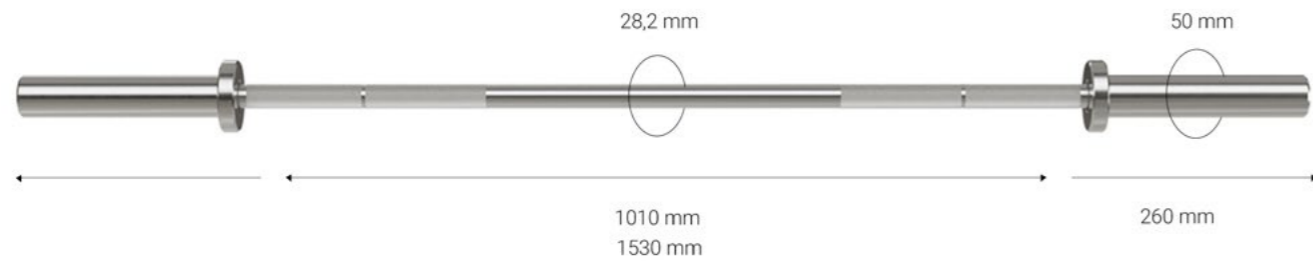

**Compact Bar 170 cm, 12,5 kg /+180 kg**

Art.nr: 417

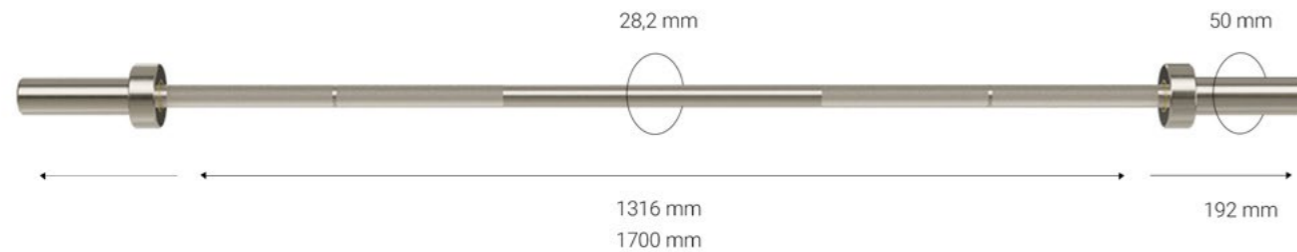

**Hex Bar, 20 kg /+250 kg**

Art.nr: 418

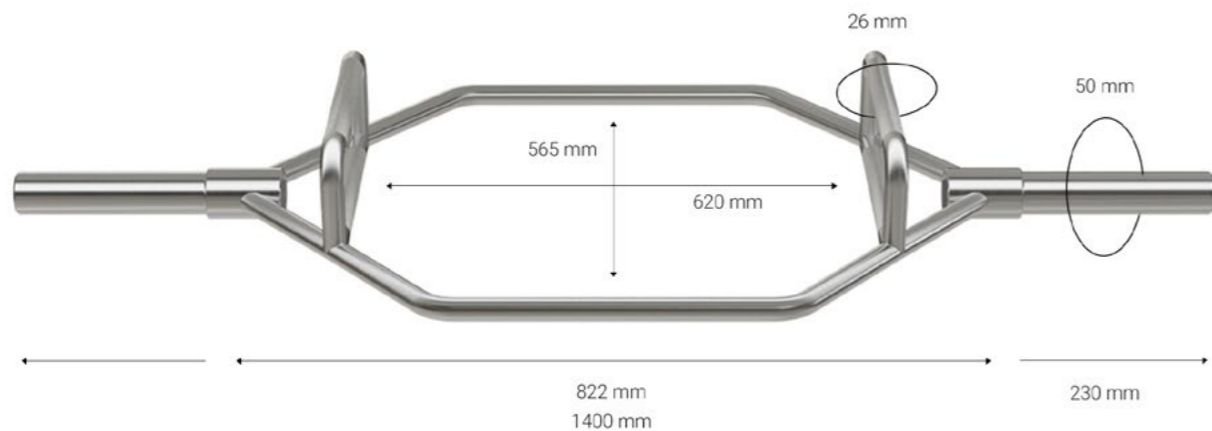

**Curved Bar, 17 kg /+680 kg**

Art.nr: 419

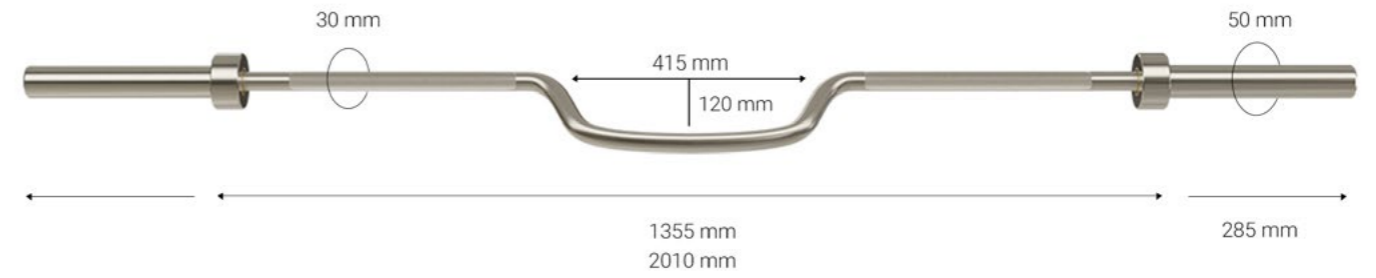

**Weightlifting Bar, Men, 20 kg /+680 kg**

Art.nr: 810

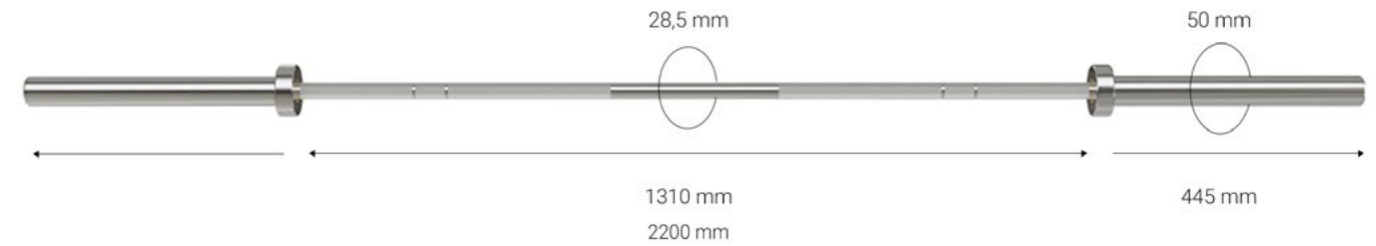

**Competition Weightlifting Bar, Men, 20 kg /+900 kg**

Art.nr: 810C

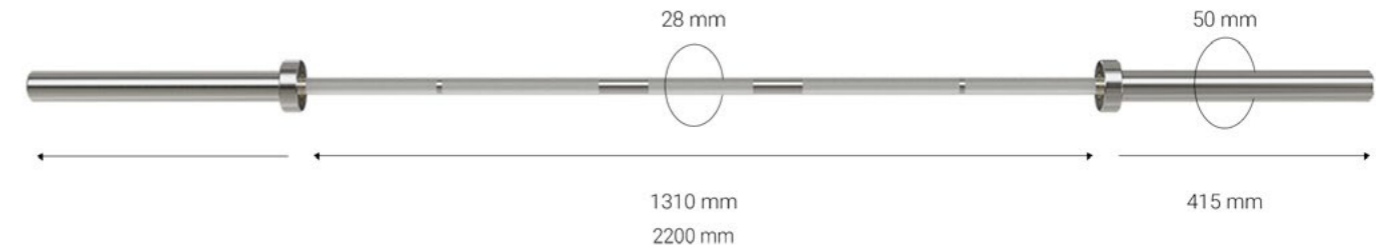

**Weightlifting Bar, Men, Black, 20 kg /+680 kg**

Art.nr: 810CB



**Cerakote Weightlifting Bar, Men, Red, 20 kg /+800 kg**

Art.nr: 810CR



**Weightlifting Bar Women, 15 kg /+450 kg**

Art.nr: 812



**Competition Weightlifting Bar, Women, 15 kg /+600 kg**

Art.nr: 812C

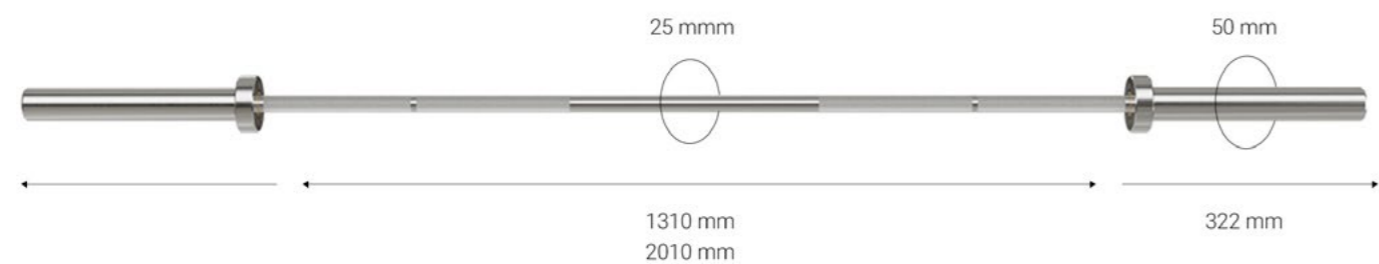

**Cerakote Weightlifting Bar, Women, Red, 15 kg /+600 kg**

Art.nr: 812CR



**Technique Bar, 10 kg /+40 kg**

Art.nr: 813

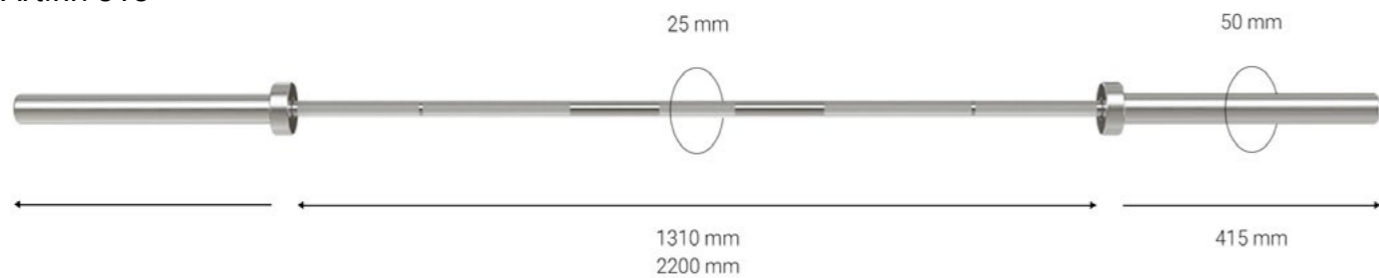

**Bend Barbell, 20 kg /+400 kg**

Art.nr: 814

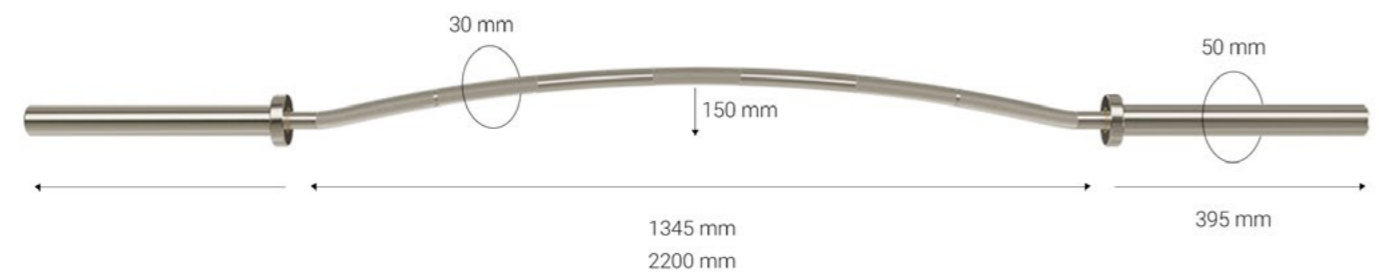

**Fat Bar, 8 kg /+300 kg**

Art.nr: 817



**Technique Bar, Premium, 10 kg /+450 kg**

Art.nr: 817T

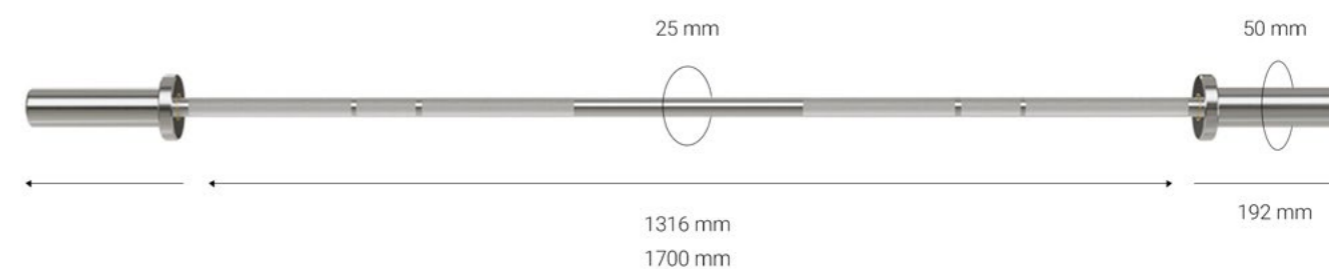

**Safety Squat Bar, 30 kg /+400 kg**

Art.nr: 818

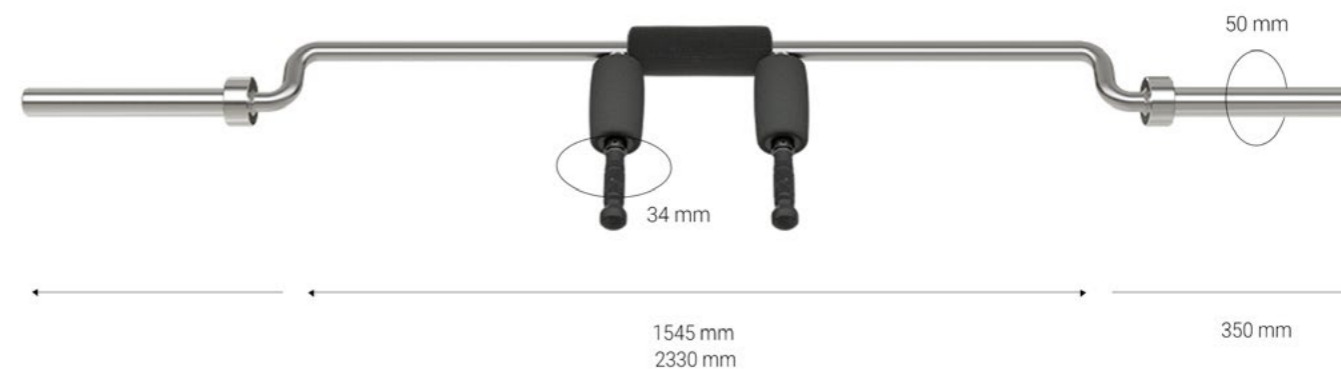

**Multi Grip Bar, 20 kg /+400 kg**

Art.nr: 819

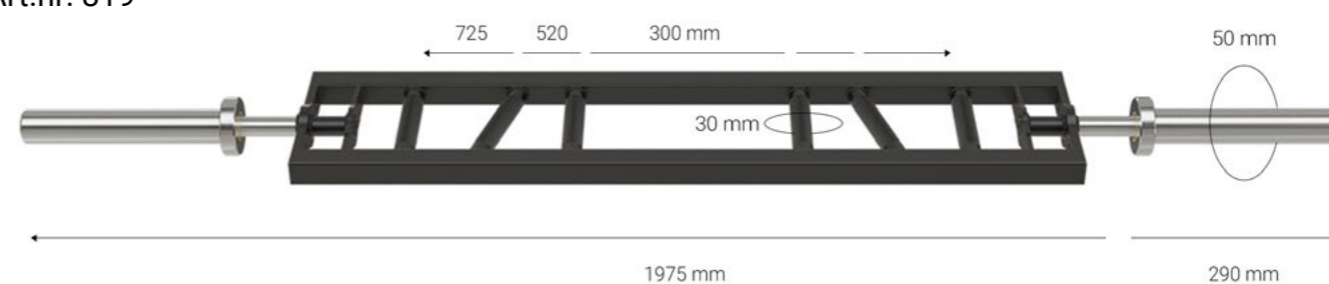

**Curved Multi Grip Bar, 20 kg /+400 kg**

Art.nr: 819C





408 Open Deadlift Bar

### Fixed Barbells PU, straight or curved

Art.nr: 825

Gymleco's fixed barbells are designed in a classic, timeless design and are covered in polyurethane material. Polyurethane is similar to strong rubber and makes the barbells extremely durable. Choose between straight or curved model.

Available in sizes:  
7.5–30 kg in 2.5 kg increments, and 30–50 kg in 5 kg increments.



### Fixed Barbells in Chrome

Art.nr: 828 / 828C

Gymleco's fixed barbells in chrome comes in a variety of sizes from 5kg up to 50kg. Made in a premium design with a highly durable chrome finish – perfect for elevating the look of your gym without compromising on quality.

Available sizes:  
Both the straight and curved barbells come in 10 different weights, from 5 kg to 50 kg, in 5 kg increments.

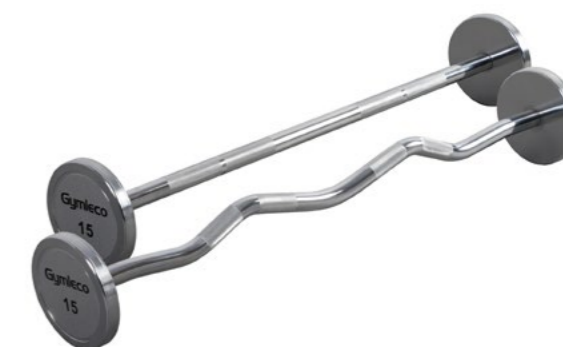

### Pump Set Polyurethane

Art.nr: 480PU-20

Here is a barbell set perfectly made for group classes in professional gyms. The weights are of polyurethane material and therefore very durable. The set is total 20 kg and consists of a barbell, a pair of spring collars and weights: 2 x 1,25 kg, 2 x 2,25 kg and 2x 5 kg.

Hole diameter: 31 mm  
Bar diameter 30 mm



### Pump Set

Art.nr: 480-20

Are you looking for a space saving barbell with weights? Then we have the solution for you! A barbell set with a total of 20 kg consisting of a barbell, a pair of spring collars and black rubber weights: 2 x 1,25 kg, 2 x 2,25 kg and 2x 5 kg.

Hole diameter: 31 mm  
Bar diameter 30 mm





### Calibrated Steel Plates with handles

Art.nr: 820

Our Calibrated Weight Plates offer precision, durability, and performance for your strength training. Made from high-quality steel, these plates are built to withstand intense workouts while ensuring accurate weight distribution. The recessed text and color markings remain clear over time, enhancing their longevity.

Hole diameter 50mm  
Available in sizes: | 0,5kg | 1kg | 1,25 | 2,5kg | 5kg | 10kg | 15kg | 20kg | 25kg



### Black Weight Plates in Rubber

Art.nr: 824B

Gymleco weight plates are made of commercial quality, with a diameter of 450 mm and a strong reinforced steel center in the middle. Perfectly suitable for the gymcenter, functional fitness box or the commercial homegym.

Hole diameter 50mm  
Available in sizes: 5kg | 10kg | 15kg | 20kg | 25kg



### Colored Weight Plates in Rubber

Art.nr: 824C

Gymleco weight plates are made of commercial quality, with a diameter of 450 mm and a strong reinforced steel center in the middle. Perfectly suitable for the gymcenter, functional fitness box or the commercial homegym.

Hole diameter 50mm  
Available in sizes: 5kg | 10kg | 15kg | 20kg | 25kg



### Bumper Plates

Art.nr: 824H

Gymleco's Training Bumpers are made of recycled, vulcanised rubber. These bumpers are designed for hard weight training. Thanks to their soft rubber they're sound-absorbing and durable. This makes the bumpers some of the toughest on the market. Fantastic shock absorbing when you lift!

Hole diameter 50mm  
Available in sizes: 5kg | 10kg | 15kg | 20kg





**Colored Weight Plates in Rubber with handles**  
Art.nr: 423

Gymleco's weight plates are made of high quality rubber and have a good design suited for any commercial gym. These weight lifting plates have handles for easy change of weights when working out.

Hole diameter 50 mm  
Available in sizes: 1,25kg | 2,5kg | 5kg | 10kg | 15kg | 20kg | 25kg | 50kg



**Black Weight Plates in Rubber with handles**  
Art.nr: 422

Gymleco's weight plates are made of high quality rubber and have a good design suited for any commercial gym. These weight lifting plates have handles for easy change of weights when working out.

Hole diameter 50mm  
Available in sizes: 1,25kg | 2,5kg | 5kg | 10kg | 15kg | 20kg | 25kg



**Black Weight Plates in Polyurethane with handles**  
Art.nr: 822

Gymleco's international weight plates with handles, enhanced with the markets strongest material (**polyurethane**) that is similar to strong rubber. These weights from Gymleco are inspired by our most popular weight plates, article 423.

They are of the highest quality and made for commercial use in the gym. The plates have handles for easy switch between machines. Unlike bumper plates these weights are hard which doesn't make them "bumpy".

Hole diameter 50mm  
Available in sizes: 1,25kg | 2,5kg | 5kg | 10kg | 15kg | 20kg | 25kg

**Urethane Fractional Bumper Plates**  
Art.nr: 824F

These small weights are excellent for small weight changes in your workout and color coded for easy identification. Premium urethane provides unmatched durability and will not damage the bar.

Hole diameter 50mm  
Available in sizes: 0,5kg | 1kg | 1,5kg | 2kg | 2,5kg | 5kg



**Technique Weights**  
Art.nr: 824T

Gymleco technique weights in a unique mixture between plastic & rubber provide long durability and quiet use. Extra wide base provides good stability, perfect for training all types of technique lifting.

Hole diameter 50mm  
Available in sizes: 2,5 kg | 5kg





**Chrome Dumbbells 1-10 kg**  
Art.nr: 430

These highly reflective and attractive dumbbells add a touch of class to any gym. These chrome dumbbells are ergonomically designed to fit comfortably in the users hand.

Available in sizes:  
1 kg | 2 kg | 3 kg | 4 kg | 5 kg | 6 kg | 7 kg | 8 kg | 9 kg  
| 10 kg



**Hex Dumbbells 1-35 kg**  
Art.nr: 433

These rubber hex dumbbells deliver the perfect balance of quality and price to any athlete. The dumbbells are hexagonal shaped and stop the weights from rolling around.

Available in sizes:  
1 kg | 2 kg | 3 kg | 4 kg | 5 kg | 6 kg | 7 kg | 8 kg | 9 kg |  
10 kg | 12,5 kg | 15 kg | 17,5 kg | 20 kg | 22,5 kg | 25 kg  
| 27,5 kg | 30 kg | 32,5 kg | 35 kg



**Premium Chrome Dumbbells 1-10 kg**  
Art.nr: 830

These high commercial chrome dumbbells are made of steel and can not be unscrewed. This make these sustainable at the commercial gym.

Available in sizes:  
1 kg | 2 kg | 3 kg | 4 kg | 5 kg | 6 kg | 7 kg | 8 kg | 9 kg  
| 10 kg



**Polyurethane Dumbbells 1-10 kg**  
Art.nr: 831

Gymleco's dumbbells are manufactured with durable material called polyurethane. Each weight comes with clear markings and comfortable handles.

Available in sizes:  
1 kg | 2 kg | 3 kg | 4 kg | 5 kg | 6 kg | 7 kg | 8 kg | 9 kg  
| 10 kg

**Rubber Dumbbells 1-10 kg, PU**  
Art.nr: 835

Gymleco's small rubber dumbbells are made of the highest quality and should be available at every gym.

Available in sizes:  
1 kg | 2 kg | 3 kg | 4 kg | 5 kg | 6 kg | 7 kg | 8 kg | 9 kg  
| 10 kg



**Polyurethane Dumbbells 5-80 kg**  
Art.nr: 836

These dumbbells are made of the highest commercial quality and covered in polyurethane material. Durable dumbbells with a well-thought-out design. All weights come with clear markings and with no risk of weights becoming loose.

Available in sizes:  
5kg | 7,5kg | 10kg | 11kg | 12kg | 12,5kg | 13kg | 14kg |  
15kg | 16kg | 17kg | 17,5kg | 18kg | 19kg | 20kg | 22 kg |  
22,5kg | 24 kg | 25kg | 26 kg | 27,5kg | 28 kg | 30kg | 32kg  
| 32,5kg | 34kg | 35kg | 36kg | 37,5kg | 40kg | 42,5kg |  
45kg | 47,5kg | 50kg | 52,5kg | 55kg | 57,5kg | 60kg | 65kg  
70kg | 75kg | 80kg



**Steel Dumbbells 10 - 100 kg**  
Art.nr: 838

Gymleco's new, unique steel dumbbells. Really robust weights that can stand hard weight training. No loose detail or surface treatment that can loosen or flatten.

Available in sizes:  
17,5 kg | 12,5 kg | 12,5 kg | 15 kg | 17,5 kg | 20 kg | 22,5  
kg | 25 kg | 27,5 kg | 30 kg | 32,5 kg | 35 kg | 37,5 kg |  
40 kg | 42,5 kg | 45 kg | 47,5 kg | 50 kg | 52,5 kg | 55 kg  
| 57,5 kg | 60 kg | 62,5 kg | 65 kg | 67,5 kg | 70 kg | 75 kg  
| 80 kg | 90 kg | and up to 100 kg at request.





### Chrome Dumbbells 5-50 kg

Art.nr: 838CR

Chrome Dumbbells from Gymleco ranges from 5 up to 50kg. A real showstopper at the gym! Made in a classic design, and a highly durable chrome finish for a long lifespan. A must have for every gym!

Available in sizes:

5kg | 7,5kg | 10kg | 12,5kg | 15kg | 17,5kg | 20kg | 22,5kg | 25kg | 27,5kg | 30kg | 35kg | 40kg | 45kg | 50kg



### Iron Kettlebells

Art.nr: KET

We introduce qualitative kettlebells in iron material, with color markings. Weights and grip diameters based on the original dimensions. Double handles of all sizes. Weight marking in both KG and LB.

Available in sizes: 4 kg to 56 kg.



### Competition Kettlebells

Art.nr: KETC

Kettlebells with one hand grip. Durable dumbbells made of cast iron with comfortable grip. Stylish and high quality kettlebells. Available in several sizes. Color marking on each kettlebell. Measure of the kettlebell does not change even if the weight does. Weight marking in both KG and LB.

Available in sizes: 8 | 12 | 16 | 20 | 24 | 28 | 32 kg



R101



R102



R103



R106



R427



R849



R226



R226C



R107



R108



R108R



R4076



R488



R847R



R847



R847N



R112



R112L



R845



R115



R811S



R811O



R851



R100



R117



108Q



117Q



R118



R402



R408



R409



R120



R122



R122R



R123



R403



R405



R404



N126



R141N + R141L



816



N32-903



A-713



A-712



A-711



N38 - 8 / 12 / 16



A-ABMAT



R140L



R482



N42-PRO



A-714



N61236



751 - G/B



A-063Belt



A-082Belt



R482N



N125



N122

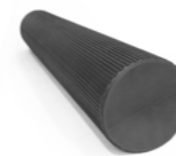

N121



R110L



R110



N68-723



N59-996



N68-726



R250



A-ABROLL



N130



N951



A-BAL



761-1,5x6



765



764



N62-657



N62-656



225-6



479





787 Bulgarian Bag

**Power Fitness sandbag 6-30kg**

Art.nr: 784

Durable and versatile training tool. Designed to build functional strength, grip, and core stability by challenging the body through unstable and dynamic movements. Ideal for exercises like squats, carries, presses, and throws.

Available in sizes:

6 kg, 8 kg, 10 kg, 12 kg, 16 kg, 20 kg, 24 kg and 30 kg



**Bulgarian Bags**

Art.nr: 787

The Bulgarian bag strengthens the muscular tolerance of the grip, wrists, arms, shoulders, back, legs, and rotational muscles. Bulgarian bags are perfect in all kinds of gym but are most often used in functional fitness.

Available in sizes:

5 kg, 10 kg, 15 kg, 20 kg and 30 kg



**Hip Thrust Soft Cushion**

Art.nr: N79-166

This soft cushion made for hip thrusts is truly a must-have at every gym. Thanks to its size, it's perfect for both professional gyms and home gyms. It's used in hip thrust exercises that you do with a barbell or some kind of weight; could be a kettlebell!

Length: 60 cm  
 Width: 40 cm  
 Height: 40 cm  
 Weight: 15,5 kg



**Hip Thrust Soft Bench**

Art.nr: N79-020

This bench is a bit bigger than the one above but similar in usage. It's perfect for both hip thrusts but also for other exercises like Bulgarian split squats and step-ups. So it's multi-functional!

Length: 100 cm  
 Width: 45 cm  
 Weight: 17 kg





**Small Foam Plyo Box**  
Art.nr: N59995-SMALL

Smaller version of our popular Foam Plyo Box below. This can be used specially for those who think that the other ones are too big and scary to jump on.

Length: 61 cm  
Width: 51 cm  
Height: 41cm  
Weight: 16 kg



**Foam Plyo Box**  
Art.nr: N59995-60

Even advanced athletes can, despite their away-trained fears, choose soft plyo boxes as they reduce the chance of being injured further.

Length: 76 cm  
Width: 61 cm  
Height: 51cm  
Weight: 29 kg



**Wooden Plyo Box**  
Art.nr: N59993

Turn over the box and get three different heights. The Plyo box is made of wood and with handles for easy movement of the box.

Length: 70 cm  
Width: 60 cm  
Height: 50 cm  
Weight: 28,5 kg



**Premium Plyo Box**  
Art.nr: 680

Gymleco's Premium Plyo Box is made in Sweden from 18mm WISA Hexagon material. Great quality and good looking finish.

Length: 76 cm  
Width: 61 cm  
Height: 51cm  
Weight: 24,6 kg

**Soft Drop Boxes /Crash Pads**  
Art.nr: A-756013

Crash pads are used in weight lifting and functional training with the purpose of minimizing the sound but also lower the impact on the equipment when you drop your barbell with weights.

Length: 75 cm  
Width: 60 cm  
Height: 13 cm  
Weight: 7,8 kg



**Hygienic Mat**  
Art.nr: A-1506008

Gymleco's hygienic stretch mat in grey/silver with a black backside. The mat is produced with an eyelet on both sides for easy suspension. Durable and easy to clean. Laminated with PVC and contains sealed foam.

1500x600x8mm



**Hygienic studio mat, rectangular**  
Art.nr: A-1736008

Every gym needs durable gym mats. Here you have our hygienic mats that are easy to wipe off after the group training or stretching. Perfect in your yoga or strength training classes or in your stretch section at the gym. With a clean and stylish design they fit into any training facility.

Available in two sizes:  
1730mm x 600mm x 8mm  
1200mm x 600mm x 8mm



**Yoga Mat**  
Art.nr:A-1836105

Gymleco's yoga mat is made of TPE with a stylish design in black with white logo. Perfect for your yoga classes where you need a durable and durable yoga mat.

1830mm x 610mm x 5mm





**Gymnastic Balls, 3 sizes**  
Art.nr: A-D55, A-D65, A-D75

Gymnastic Balls or Yoga Balls, as they are also called, are great for strength training and training your balance and coordination. You can do a variety of different exercises with the Yoga Balls and they are a must in the big commercial gyms as well as a great addition in your home gym.

Available in sizes 55 cm, 65 cm and 75 cm



**Balance Trainer Ball**  
Art.nr: N85

Gymleco Balance Trainer is a commercial half-ball that is a well-regarded tool in the gym. A new and unique training method, which makes it possible to combine aerobic, muscle and torso training.

Included: Pump and handles



**Wall Balls**  
Art.nr: 789

Gymlecos Wall Balls are designed in strong and robust quality. Made for heavy weight training and functional fitness at both boxing and commercial gyms. Also suitable for Strongman training.

Available in sizes:  
2 kg | 3 kg | 4 kg | 5 kg | 6 kg | 7 kg | 8 kg | 9 kg | 10 kg | 11 kg | 12 kg | 14 kg

**Slam Balls**  
Art.nr: 788

Gymlecos Slamballs gives you the opportunity for a variety of functional exercises and thanks to the fact that we have developed Slamballs in various sizes you can adjust your weight on the Slamball according to your ability and wishes.

Available in sizes:  
2 kg | 4 kg | 6 kg | 8 kg | 10 kg | 12 kg | 14 kg | 16 kg | 15 kg | 18 kg | 20 kg | 25 kg | 30 kg | 35 kg | 40 kg | 45 kg | 50 kg | 55 kg | 60 kg | 70 kg | 80 kg | 90 kg | 100 kg



**Medicine Ball 1-10 kg**  
Art.nr: 786

The Gymleco Medicine Ball is a versatile tool perfect for enhancing strength, coordination, and overall fitness. Designed with durable, impact-resistant materials, it withstands intense workouts while offering a secure grip with its textured surface.

Available in sizes:  
1 kg | 2 kg | 3 kg | 4 kg | 5 kg | 6 kg | 7 kg | 8 kg | 9 kg | 10 kg



**Medicine Ball with handles**  
Art.nr: 785

The Gymleco Medicine Ball with Handles combines versatility and durability, making it perfect for dynamic strength and core training. Its ergonomic handles provide a secure grip, allowing for a wide range of exercises, while the high-quality construction ensures it can withstand intense workouts.

Available in sizes:  
3 kg | 4 kg | 5 kg | 6 kg | 7 kg | 8 kg | 9 kg | 10 kg





196 Weight Rack 8 Placements

### Weight Rack with 2 barbell holders

Art.nr: 895

This is a robust weight tree with a clean and good looking design. An extremely popular product and a must in the gym! The rack has six hangers for international weights and two holders for international barbells.

Length: 46,5 cm  
 Width: 61 cm  
 Height: 133 cm  
 Weight: 15,5 kg



### Weight Rack 6 Placements

Art.nr: 195

A compact and stylish weight tree with six bars to store weight plates in different sizes. Perfect choice for you that have weights from 1,25 kg up to 25 kg.

Length: 50 cm  
 Width: 46,5 cm  
 Height: 133 cm  
 Weight: 16 kg



### Weight Rack 8 Placements

Art.nr: 196

A compact and stylish weight tree with eight bars to store weight plates in different sizes. You can fit a lot of weights on this one. Perfect if you have weights from 1,25 kg up to 25 kg. This one is our best seller!

Length: 50 cm  
 Width: 46,5 cm  
 Height: 155 cm  
 Weight: 16 kg



### Wall Mounted Weight Rack

Art.nr: 197

A smart and compact wallmounted weight tree with 4 placements for international plates. An extremely space efficient and good looking solution to store your weight plates at your gym.

Length: 50 cm  
 Width: 46,5 cm  
 Height: 155 cm  
 Weight: 12 kg





**Dumbbell Rack,  
10 pairs, 2,2m**  
Art.nr: 440

Length: 220 cm  
Width: 59 cm  
Height: 75 cm  
Weight: 45 kg



**Dumbbell Rack  
5 pairs, 1,2m**  
Art.nr: 440F-1200

Length: 120 cm  
Width: 64 cm  
Height: 77 cm  
Weight: 40 kg



**Dumbbell Rack  
10 pairs, 2,4m**  
Art.nr: 440F-2400

Length: 240 cm  
Width: 62 cm  
Height: 77 cm  
Weight: 73,5 kg



**Barbell Rack, 10 places**  
Art.nr: 451V

Length: 77 cm  
Width: 80 cm  
Height: 15 cm  
Weight: 24,5 kg



**Barbell Rack, 5 places**  
Art.nr: 452V

Length: 62 cm  
Width: 71 cm  
Height: 15 cm  
Weight: 12 kg



**Wallmounted Barbell  
Holder, 2 places**  
Art.nr: 472

Length: 13 cm  
Width: 30 cm  
Height: 20 cm  
Weight: 3,5 kg



**Dumbbell Rack  
5 pairs, 1,15m**  
Art.nr: 840-5

Length: 115 cm  
Width: 58 cm  
Height: 62,4 cm  
Weight: 41 kg



**Dumbbell Rack  
10 pairs, 2,3m**  
Art.nr: 840

Length: 230 cm  
Width: 60 cm  
Height: 62,4 cm  
Weight: 67 kg



**Standing Dumbbell  
Rack 10 pairs**  
Art.nr: 441

Length: 32 cm  
Width: 32 cm  
Height: 126 cm  
Weight: 15,5 kg



**Barbell Storage, 10 places**  
Art.nr: 451

Length: 65 cm  
Width: 46 cm  
Height: 15,5 cm  
Weight: 25 kg



**Barbell Storage, 5 places**  
Art.nr: 452

Length: 65 cm  
Width: 40 cm  
Height: 15,5 cm  
Weight: 20 kg



**Wallmounted Barbell  
Holder, 5 places**  
Art.nr: 475

Length: 13 cm  
Width: 66 cm  
Height: 15,5 cm  
Weight: 7,6 kg



### Rack for pumpset

Art.nr: 480

The smart design makes it easy to storage 30 sets of pump weights and barbells on this rack. This is the perfect rack and storage for the group training area.

Length: 60 cm  
Width: 122 cm  
Height: 163 cm  
Weight: 51 kg



### Barbell Rack, 10 fixed bars

Art.nr: 450H

Well-designed barbell rack for fixed barbells in straight or curled model. Clean and beautiful with a black frame and hangers in chrome. The barbell storage is designed for commercial use which makes it perfect for professional gyms.

Length: 87 cm  
Width: 84 cm  
Height: 139 cm  
Weight: 60,5 kg



### Barbell Rack, 5 fixed bars

Art.nr: 445H

Well-designed barbell rack for fixed barbells in straight or curled model. Clean and beautiful with a black frame and hangers in chrome. The barbell storage is designed for commercial use and is therefor suitable for professional gyms.

Length: 87 cm  
Width: 84 cm  
Height: 139 cm



### Wall mounted Barbell Rack

Art.nr: 446

This horizontal wall mounted barbell rack offers convenient storage for 6 different barbells. Effective when you want to free up some space around your rack or on the floor and have the barebells on the wall instead.

### Kettlebell Rack

Art.nr: 443

Gymleco kettlebell Rack that can fit up to 10-15 kettlebells depending on kettlebell size.Very stable and flexible design with rubberized shelves for quiet and safe management.Can also be used as a stand for slam balls, wall balls, etc.

Length: 53 cm  
Width: 125 cm  
Height: 67 cm  
Weight: 32,5 kg



### Rack for Medicine Balls, 10 pieces

Art.nr: 470

Enhance the organization and aesthetics of your gym with the Gymleco Rack for Medicine Balls. Crafted with precision and durability in mind, this rack is designed to keep your medicine balls or wall balls in a neat and orderly fashion, while adding a touch of style to your fitness space.

Length: 35 cm  
Width: 90 cm  
Height: 165 cm  
Weight: 25 kg



### Carriage for handles

Art.nr: 495

Optimal handle storage for your gym. This handles and accessories carriage has two sides which means a lot of equipment can be stored in it. It also has wheels which means that you can move it wherever you need to.

Length: 129 cm  
Width: 50 cm  
Height: 145 cm  
Weight: 65,5 kg



### Wallmounted handles and accessory board

Art.nr: 495-1

The handle board has place for 14 exercise handles, training accessories, weight lifting belts etc.

Width: 120 cm  
Height: 80 cm  
Weight: 18 kg

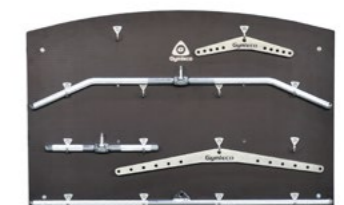



### Wall mounted Dip Handles, Angled

Art.nr: 755D

Gymleco's wall mounted dips handles are well thought out in design and form. The angled handles give you the right position for your dip training. Well suitable for the big gym or the smaller home gym.

Diameter dip bars 40 mm



### Wall mounted Dip Handles

Art.nr: 755S

Gymleco's wall mounted individual dip handles are incredibly well constructed and strong. Easily to train dips and the design is space-saving. Well suitable for the big gym or the smaller home gym.

Diameter dip bars 40 mm



### Wall mounted Rack for Gymballs

Art.nr: 465

This wall mounted gymball rack is a great way to prevent the exercise ball from rolling around and getting in the way. The stand is suitable for balls with a diameter between 45-80 cm. It is designed and manufactured from the highest quality materials and powder coated with black paint.

Length: 60 cm



### Mat Suspension

Art.nr: 460

Gymleco's adjustable mat hanger. Perfect for hanging our hygienic mats on. Perfect for both the group training room where there is a need for organizing yoga mats or at the home gym where you want the mats hanged neatly on the wall.

Length: 40-70cm

### Mat storage, single hook

Art.nr: 461

Gymleco's mat hanger with one hook, perfect for hanging Gymleco's Hygienic Mat with one eyelet. It's optimal for all professional gyms where organization of the mats is needed or for the home gym when you want the mats hanged neatly on the wall.



### Ball Target, Double

Art.nr: 689

Wallball target is used in functional training when you throw a weighted ball to the target area. It's suitable for Gymleco racks with art.no: 601, 602, 649 & 848. Can also be wall mounted.

Heights: Men 305 cm c/c  
Ladies 274 cm c/c  
Diameter 40 cm.



### Split Squat Stand, Adjustable bench

Art.nr: 893

Perfect for bulgarian splits squats! Invest in this single leg squat stand that lets your members train bulgarian split in an ergonomic way. Does not take much space at the floor either. Win-Win!

Adjustable height 39 – 53 cm



### Adjustable step

Art.nr: 892

The ultimate gym companion – the versatile step stool that doubles as a chair, exercise tool and unloading aid. Made from left over materials, this step stool is both sustainable and designed to withstand the rigors of gym use.

Adjustable height 39 – 53 cm





848 Half Rack

### Power Rack /Cage

Art.nr: 649

This Power Rack is excellent for squats, bench press and chins training, among other things. The rack is designed with safety frames that makes it easy for both the beginner and the experienced weightlifter to use the rack.

2 reversible chin bars included: D25mm + D40mm  
Safety barriers included.

Length: 129 cm  
Width: 89 cm (128 cm with weight hangers)  
Height: 240,5 cm  
Weight: 158 kg



### Half Rack

Art.nr: 848

This one-sided Half Rack is a well designed rack with the possibility of a large number of exercises such as bench press, squats, chins, pull-ups, standing rowing, etc. A robust rack designed for commercial gyms.

Safety barriers 500mm included.

Length: 116 cm  
Width: 164 cm (with weight hangers)  
Height: 230 cm  
Weight: 101 kg



### Half Rack, Double Sided

Art.nr: 848D

Half Rack in double model is a great rack with the possibility of an extremely large number of exercises such as bench press, squats, chins, pull-ups, standing rowing, etc. Easy to place on the gym thanks to the compact design. Commercial quality for the professional gym.

Safety barriers 500mm included.

Length: 202,5 cm  
Width: 164 cm (with weight hangers)  
Height: 230 cm  
Weight: 180 kg



### Wallmounted Rig Art.nr: 601

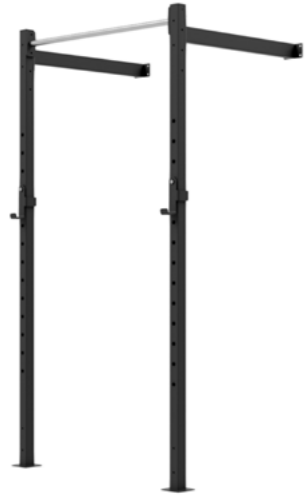

This wall-mounted Gymleco rig, also known as a functional fitness training station, is a stylish and highly stable solution for all gym environments. It is multifunctional and allows for a wide variety of exercises such as squats, pull-ups, and many other strength and functional training movements. Designed and manufactured by Gymleco, the rig is built using high-quality materials to ensure durability and performance.

The rig is mounted to both the wall and the floor for maximum stability. It also offers several extensions and modular options, allowing you to expand and customize the rig as needed. An outdoor treatment option is available as well, providing additional surface protection so the rig can withstand outdoor environments.

Two barbell holders are included with the rig, allowing you to easily add a barbell and start squatting right away.



The rig equipped with safety spotters and weight storage.



The rig expanded with two barbell stations and a center beam.

### Rig with 6 liftings places Art.nr: 602

A fantastic training station for any gym. It features both low and high pillar positions, allowing you to integrate rope and ring stations as needed. The rig includes a total of 11 pull-up stations, six of which can also be used as squat stations.

It can be equipped with a variety of accessories such as dip racks, safety spotters, weight storage, and more. The best part is its modular design – you can build the rig as large as you want and configure it with the components that suit your needs. The possibilities are endless.

Height: 271 - 346 cm  
Width: 122 cm | 142 cm | 182 cm  
*Custom lower heights can be manufactured if required*



### Complete Crossbox Station Art.nr: 610

Crossbox station provides versatile training for the whole body where you can do a lot of different exercises. The station can be built with complementary accessories completely according to your own conditions and wishes. You can for example build your station with additional parts such as a monkey bar, punching bag and squat suspension. This is a best seller thanks to the compact size which makes it easy to place in any gym regardless of surface.

Length: 345 cm  
Width: 245 cm  
Height: 236 cm



### Monkey Bar Rig Art.nr: 614

The purpose of a Monkey Bar Rig is, among other things, to train grip strength by moving from one side to the other while hanging by your hands. The rig can also be used to hang equipment such as punching bags and pull-up bars, adding more training options to the gym. Many users also attach TRX straps to the rig for additional functional training possibilities.

Length: 410 cm  
Width: 170 cm  
Height: 229 cm





### **Gymleco Pulling Rope NEW!**

Art.nr: 760-1.5x12



A 15 meter training rope that builds strength, endurance, and grip. Attach it to the *Gymleco Functional Sled* for dynamic pull exercises that engage your core and entire posterior chain.

### **Conan Wheel**

Art.nr: 665



Also called the Conan Circle. This is a classic strongman equipment which is used by adding weight plates on it and carry around the weight in a circulating motion.

Used with international weight plates. The lifting arm can be adjusted in height from 123 cm to 143 cm. The distance from the center to the start of the lifting arm is 160cm (which gives about 10 meters of walkway per turn)

### **Fitness Yoke**

Art.nr: 664



Gymleco's own Fitness Yoke with adjustable height. Beautiful, clean design made of strong material, making the piece timeless. A perfect gym equipment for heavy strongman training.

The diameter of the grip 60 mm  
Highest position: 177cm  
Lowest position: 132cm  
Length: 120 cm  
Width: 40 cm  
Height: 108 - 164 cm  
Weight: 50 kg

### **Prowler Sled**

Art.nr: 685



Prowler Sled combines the training of strength and endurance of legs, waist and arms. Often used in functional fitness but also in the traditional gyms, preferably where there's space for a artificial grass track.

Length: 101 cm  
Width: 67 cm  
Height: 103 cm (with the handles)  
Weight: 50 kg



**Gymleco Functional Sled NEW!**

Art.nr: 675

A versatile and robust training sled for explosive strength and endurance. Built from durable steel and equipped with five removable poles for varied grips and techniques. Perfect for training legs, hips, core, back, and arms. For maximum effect, combine with our pulling rope.

Length: 102 cm  
 Width: 60 cm  
 Height: 100 cm  
 Weight: 50 kg



**Gymleco Sled, 20 kg NEW!**

Art.nr: 884

A compact yet heavy-duty mini sled designed for all types of sled pulling. Perfect for functional training, and easy to set up in single or double configuration for harness or rope work.

Length: 63,2 cm  
 Width: 44 cm  
 Height: 36,8 cm  
 Weight: 20 kg



**Gymleco Sled, 50 kg NEW!**

Art.nr: 885

A versatile, well-balanced sled for tough functional training – built for pushing and pulling in any direction, with generous leg clearance. Delivered with four handle tubes and one carabiner hook (10x100 mm).

Length: 98,5 cm  
 Width: 60 cm  
 Height: 100,8 cm  
 Weight: 50 kg



**Bumper Plate & Slam Ball Rack**

Art.nr. 896

Build your Gymleco rack according to the needs of your gym.

Gymleco's stylish and durable multi-storage rack is designed to keep your gym organized and efficient. It provides space for weight plates, dumbbells, wall balls, slam balls, barbells, skipping ropes, resistance bands, and much more. With this versatile storage solution, the possibilities are endless.

The 896 storage system can be fully customized to suit your specific needs. Add three shelves if you want to maximize storage in a limited space. Expand the width if you have a large amount of equipment and want everything gathered in one place. Combine different shelf types to ensure that every piece of equipment has its dedicated spot in the rack.



### Bowl for Magnesium /Chalk

Art.nr: 692

A compact and smart designed standing bowl for storing chalk blocks or powder. This Gymleco Standing Bowl for chalk is perfect for commercial gyms and training boxes.

### Push-up Bars

Art.nr: 621



These high-quality Gymleco Parallettes, or so-called Push-up Bars are used in calisthenics and help you get more power in exercises that strengthen the arms, shoulders and chest.

Length: 50 cm  
Height: 27 cm  
Width: 34 cm

### Barbell Lifter / Bar Jack

Art.nr: 898



Gymleco's barbell lifter is a tool that makes it easy to change weights during heavy weight training. Just roll over the bar with weights on and lift it up a few cm to change weights.

Length: 126 cm  
Width: 32 cm  
Height: 118 cm  
Weight: 12 kg

### Barbell Lift Mini

Art.nr: 899



Gymleco's barbell lift (mini) is a tool that makes it easy to change weights during heavy weight training. Just roll over the bar with weights on and lift it up a few cm to change weights.

### Atlas Stones

Art.nr: 868

Atlas Stones are made of concrete shaped into a round ball. These are traditionally used in Strongman events but are now also popular on gyms that wants to offer something different.

Sizes from 50 kg to 110 kg (diameter 41,5 cm-48 cm)



### Podium set for Atlas Stones

Art.nr: 867

Gymleco's Podium for Atlas Stones are an essential part of your Strongman equipment. The podiums are robust and made of the highest quality to make sure that you can lift as heavy and as much as you'd like.

The podium is available in sizes 150 cm, 135 cm and 120 cm, but can also be ordered in other sizes.



### Sledgehammer

Art.nr: N31

Are you ready to ramp up your gym and challenge your gym members like never before? Here is the ultimate tool for your strength training, functional training, and strongman training. Available in various weights ranging from 5 kg to 30 kg or as a set.

Grip Diameter: 35-42 mm  
Length: 86-103 cm



### Strongman Sand Bags, XS - XL

Art.nr: 869

Gymleco's Strongman Sandbag is an excellent training equipment for both strongman, functional fitness and other free weight training. A good option for atlas stones or slamballs. The sandbags are great for training exercises such as front squats and sandbag carries. Sand is not included.

Available in sizes 30 kg, 45 kg, 65 kg, 85 kg, 115 kg





**Farmers Walk**  
Art.nr: 666

Gymleco's Farmers Walk Handles are robust and truly durable with generous space between the equipment for user's legs. Upward-angled weight holders for longer durability of the equipment.

Weight: 15 kg / piece  
Add weights with 50 mm hole diameter.

**Strongman Log Bar 32 kg**  
Art.nr: 668



Gymleco's Log Bar is designed with a neutral grip optimized to develop maximum strength by reducing strain on the shoulders. Log Bar used in press, lifting, benching and rowing exercises.

Length: 117,5 cm  
Grip 30mm / 62cm c/c

**Strongman Log Bar 50 kg**  
Art.nr: 669



Log Bar 50 kg is a traditional equipment for Strongman training. It is a bar used in numerous training exercises such as bench press, military presses and back rows. The position of the handles is ideal to obtain a greater and comfortable balance.

Length: 177,5 cm  
Grip 30mm / 51 cm / 69 cm c/c



**Metal Wall Bar, Black**  
Art.nr: 770

Gymleco Wall Bar is a robust and stylish wall-mounted wall bar made of black metal – perfect for both commercial gyms and home gyms. The compact, space-efficient design saves floor space while offering many training possibilities for the entire body, from pull-ups and leg raises to core exercises and stretching.

Width: 82 cm  
Height: 224 cm  
Weight: 40 kg

**Wooden Wall Bars with Chins**  
Art.nr: 775W

Wooden Wall Bars is a great piece of gym equipment. You may have seen it before in gyms or schools where they're used for coordination, stretch or strength. An ideal multi-functional gym equipment for not only commercial gyms and home gyms but also sports medicine clinics, hospitals and schools. The Chins rack in our Wall Bar can be changed in height.

L: 53 cm. W: 80 cm. H: 220 cm



**Peg Board**  
Art.nr: 611

Gymleco's Peg Board is designed and manufactured with the absolute finest quality. It has a total of 35 holes and is made of strong wooden material. Training in a pegboard is extremely heavy and good for your grip strength, as you hang your hands on two sticks and move forward, up and down with them.

Two sticks of oak are included.  
L: 242. H: 30 cm.



**Punching Bag**  
Art.nr: N214

Designed to hold hard boxing training at the gym. The bag is 130 cm long which makes it possible for any body length to train on. Mounted either from the ceiling or hanging from a rig.

Width: 40 cm  
Length: 130 cm  
Weight: 40 kg



**Standing Punching Bag**  
Art.nr: N224

This standing punching bag is in a durable PVC material with a filling in foam plastic. It is made for lighter punch training. The base is filled with about 75 kg of sand for stability. Sand is not included in delivery.

Diameter (maximum): 56 cm  
Height: 172 cm



# Gymleco Distributors



## Find your local distributor

Scan the QR code to find your local distributor.  
If your country is not listed, our Head Office will  
be happy to assist you directly.

We sell and ship worldwide.

**Scan for distributors**

[gymleco.com/pages/distributors](https://gymleco.com/pages/distributors)

## The Head Office | Sweden

Fitness Trade Europe AB



[gymleco.com](https://gymleco.com)



+46 8-500 052 08



[contact@gymleco.se](mailto:contact@gymleco.se)

## Follow us on social media

Instagram, Facebook, LinkedIn, YouTube, TikTok  
[@gymleco](#)

[www.gymleco.com](http://www.gymleco.com)  
@gymleco